



Thermal Metric Summary Report

(June 2015 Update)

Building Science Corporation

3 Lan Drive Suite 102
Westford, MA 01886

June 18, 2015

Executive Summary

This report provides a summary of the Thermal Metric Project and results of Reference Wall testing. The original report, released in October of 2013, did not include any test results for an ocSPF-insulated reference wall. This update of the report includes test results for two ocSPF reference walls, plus test results for two proprietary walls: one R15 fiber glass batt-insulated wall, and one dense-packed fiber glass insulated wall, both with a focussed air sealing package (caulked joints between all framing elements and the structural sheathing). Test results for the ocSPF walls can be found in Section 3.5 of this report. Test results for the proprietary walls can be found in Appendix A.

The Thermal Metric Project is a multi-year collaborative research project headed by Building Science Corporation (BSC) and a group of industry partners. The long-term goal of this project was to develop a new metric for the thermal performance of building enclosures that better accounts for known physical heat flow mechanisms (particularly natural and forced convection) and operating conditions. This report provides an overview of the project's history, a description of experimental procedures, and a detailed presentation of testing results on a set of reference walls which can be used for baseline comparison for future testing.

The Thermal Metric Project was initiated in response to renewed focus on building system performance and increasing use of a broader range of building materials and systems. These factors highlight the short-comings of the dominant thermal performance metric, namely R-value. Contemporary insulation materials and systems are more or less sensitive to thermal bridging, workmanship (i.e. quality of installation), internal convection and through convection (i.e. infiltration, exfiltration, windwashing and re-entrant looping). The impact of such 'anomalies' and 'defects' is not captured in the standard (label and installed) R-value metric.

Following an intensive literature review by BSC, a need was identified to better account for known physical heat flow mechanisms (particularly natural and forced convection) and operating conditions. In 2008, BSC proposed new equipment and techniques, based on ASTM standards, to address this need. A consortium of six industry partners joined BSC in the privately-funded development of the new thermal performance metric and the associated test method:

- Dow Building Solutions
- Honeywell
- Huntsman Polyurethanes
- Icynene
- North America Insulation Manufacturer's Association (NAIMA)
- Greenfiber

2015-06-18 – Thermal Metric Summary Report (June 2015 Update)

A novel hot box was designed and built, with construction, commissioning, and calibration completed between 2007 and 2009¹. This apparatus improved on standard hot box design in several critical ways. Key improvements include the ability to:

- test higher R-value enclosure assemblies (which have lower heat fluxes),
- expose enclosure wall samples to realistic temperature differences while maintaining the interior temperature at normal room temperatures, and
- measure the impact of imposed airflow at a given pressure difference across the specimen in both directions.

In 2010, a baseline set of walls developed within the partner group were tested at a private laboratory in Waterloo, ON, Canada. The set included six walls using 2x4 construction, one with 2x6 construction, five different stud cavity insulations, and one exterior insulation application. Testing of these walls resulted in a set of reference values for use in future research and testing, provided in Section 3 of this report.

Reference wall testing also provided an opportunity to re-examine previous approaches to measuring and understanding the thermal performance of whole assemblies. Section 2 of this report uses data from the Thermal Metric hot box to discuss advantages and limitations of Installed R-value, Center-of-Cavity R-Value, Clear-Wall R-value, and concepts of temperature dependency and air leakage and interaction. **A comparison of R-value metrics demonstrates the impact of thermal bridging and material property variability.** As seen in the figure below, R-values were significantly higher for the Center-of-Cavity metric (which does not account for thermal bridging) versus the Clear-Wall metric (which does). Similarly, low-conductivity framing led to higher R-values than high-conductivity framing. **Designers and building scientists should be aware of the variability of building materials and its potential impact on the thermal performance of wall assemblies.**

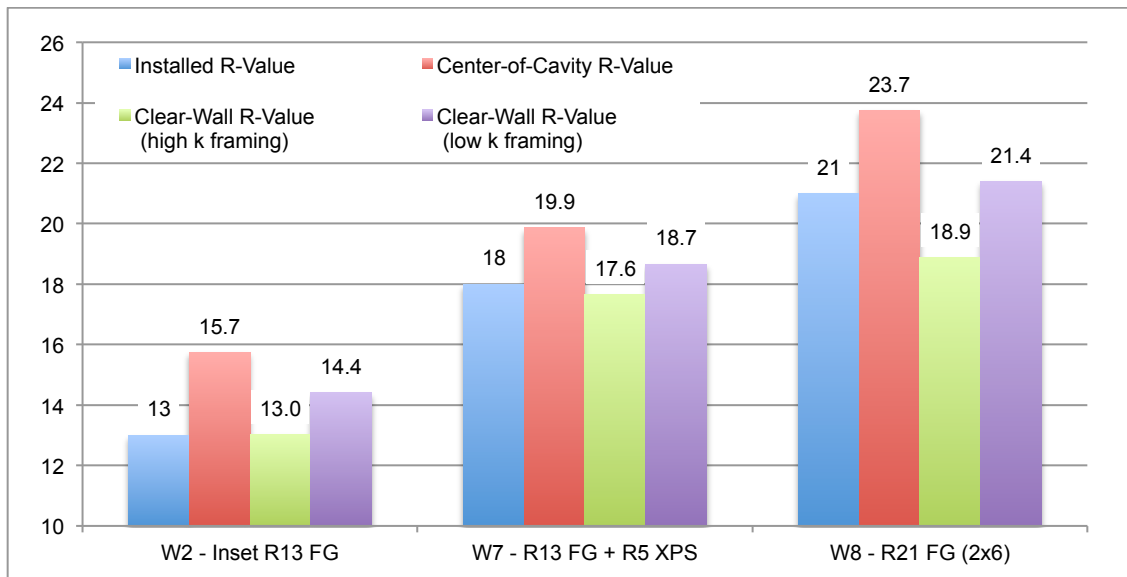

Figure ES-1 – Common Thermal Metrics for Reference Walls 2, 7, and 8

¹ See “Building America High-R Enclosures Research Project: Construction, Commissioning & Calibration of a Novel Hot Box Apparatus for High-R Enclosure Performance Measurement”

Results also showed that **the thermal conductivity of materials is dependent on temperature**. For most materials conductivity varies linearly with temperature (over the range of temperatures experienced by buildings). Typically, materials exhibit a higher thermal conductivity (and lower R-value / in.) at higher temperatures and a lower thermal conductivity (and higher R-value / in.) at lower temperatures. However, different materials can exhibit different patterns of temperature dependency. Porous, air-filled insulation materials tend to have steeper slopes than closed-pore, refrigerant-filled insulation materials. There are also some major exceptions. For example, some polyisocyanurate insulations used in the TM Research Project exhibit a sharp increase in thermal conductivity (and decrease in R-value/in.) as temperatures approach and go below freezing.

Air leakage was found to be a complex factor in thermal performance. ***Air leakage always increases the total heat flow through the building enclosure. However, air interacts with the materials in an assembly as it travels through.*** This interaction changes the temperature field in the assembly and through an assembly. The Thermal Metric wall test results provide strong evidence of the interaction between conductive and convective heat flows. This interaction results in heat exchange between the air and the materials inside the wall assembly and the total measured heat flow will be less than predicted by the commonly used discrete air leakage model.

In summary, a number of important and interesting observations have come out of the Reference Wall tests:

- When walls are constructed with the same installed R-value in the stud space, and are air sealed both inside and outside (i.e. there is effectively zero air leakage through the assembly), they exhibit essentially the same thermal performance regardless of the type of insulation material used.
- All of the tested wall assemblies were subject to thermal bridging regardless of the type of insulation material used in the stud space. Thermal bridging through the framing resulted in a roughly 15% decrease in thermal performance.
- Commercially available 2D and 3D heat transfer models provided good predictions of the thermal bridging in the assemblies tested, as did the parallel path method described in the ASHRAE Handbook of Fundamentals and other texts.
- All of the insulation materials exhibited temperature-dependent thermal performance (i.e. changes in insulation R-value with changes in mean temperature). The mechanisms that explain this phenomenon are well understood; however, there is a lack of relevant material-property information (i.e. measurements of insulation R-value at different temperatures).
- In this study, temperature dependency of insulation R-value was accounted for by material-specific thermal conductivity measurements (made at the hot-box test temperatures). The temperature-dependence effect resulted in improved thermal performance at lower mean temperatures (e.g. an outdoor temperature of 0°F, -18°C resulted in roughly a 10% improvement in thermal performance of the insulation) and reduced thermal performance at

2015-06-18 – Thermal Metric Summary Report (June 2015 Update)

higher mean temperatures (e.g. an outdoor temperature of 144°F, 62°C resulted in roughly a 15% decrease in thermal performance of the insulation).

- All of the reference test wall assemblies were subjected to significant temperature differences: up to 50°C or 90°F in the winter tests and up to 40°C or 72°F in the summer tests. Natural convective looping was not noted in any of the wall assemblies.
- All wall assemblies experienced a loss in thermal performance due to air movement through the assembly. This is true for all of the assemblies tested regardless of the type of insulation material used (e.g. cellulose, fiberglass, ocSPF, ccSPF, XPS).
- The energy impact of airflow depends on the flow path, the interaction between the air and the solid materials in the assembly, and the installed R-value of the assembly.
- Conventional energy models (i.e. those that account for air leakage energy using $Q=mc\Delta T$) may over-predict the negative energy impact on walls that have a significant interaction effect (e.g. air moving through insulation).

These results have yielded an initial draft of a new thermal metric that was presented by Chris Schumacher and Dave Ober at the Westford Symposium on Building Science in August of 2013.

2015-06-18 – Thermal Metric Summary Report (June 2015 Update)

Figure 1 – Schematics of Conventional Guarded Hot Box (top), Conventional Calibrated Hot Box (middle) and Thermal Metric Research Hot Box (bottom)	5
Figure 2 – Upper and Lower Heating Arrays with Cooling Coil in Meter Box	7
Figure 3 – TM Hot Box Schematic in Cold Climate mode (left) and Hot Climate mode (right).....	8
Figure 4 – TM Hot Box Schematic indicating Active Liquid Guard	8
Figure 5 – Double Guard: Guard Box (Left) and Liquid Guard Loop on Meter Box (Right)	9
Figure 6 – TM Hot Box Schematic indicating Cartridge (left) and Conventional Guarded Hot Box Schematic (Right).....	10
Figure 7 – Section through Wall Cartridge with Meter, Guard and Climate Boxes in Position	11
Figure 8 – Temperatures & Heat Flux at 22°C (71.6°F) Meter Side & -18°C (0.4°F) Climate Side.....	12
Figure 9 – Wall Cartridge with Test Wall Specimen Installed & Instrumented for Testing	12
Figure 10 – TM Hot Box Schematic indicating Air Transfer System	13
Figure 11 – Guard Fan (Left) & Air Transfer System (Center)	14
Figure 12 – 1/16" Aluminum Stock Spacer	16
Figure 13 – Spacer Installation	16
Figure 14 – Installed Bottom Plate Spacers	16
Figure 15 – Electrical Installed and Horizontal Gap Visible.....	17
Figure 16 – Drywall Spacers and Fiber Glass Batt Installed	17
Figure 17 – Tyvek Installed but Untaped	18
Figure 18 – Drywall Installed	19
Figure 19 – Installed Switch and Plug	19
Figure 20 – 1/32" Wall Spacers.....	20
Figure 21 – Imposed Gap Analysis	20
Figure 22 – Sealed Wall Wire Penetration.....	22
Figure 23 – Final Wire Seal with Double Tape Layer.....	22
Figure 24 – Meter Box Side, Grid of Double-Sided Tape	23
Figure 25 – Meter Box Side, Polyethylene Installed	23
Figure 26 – Climate Box Side, Tape Grid	24
Figure 27 – Climate Box, Polyethylene Installed.....	24
Figure 28 – Tracer Gas Decay and Mass Flow.....	25
Figure 29 – Temperature Measurement Locations	28
Figure 30 – Original Flanking Correction	32
Figure 31 – Wall 2, Wall 3, and Wall 4 Air Transfer Rates in CFM	34
Figure 32 – Wall 2, Wall 3, and Wall 4 Air Transfer Rates in CFM/ft ²	34
Figure 33 – Wall 2, Wall 3, and Wall 4 Air Transfer Rates in Watts	35
Figure 34 – Wall 2, Wall 5, and Wall 6 Air Transfer Rates in CFM	36
Figure 35 – Wall 2, Wall 5, and Wall 6 Air Transfer Rates in CFM/ft ²	36
Figure 36 – Wall 2, Wall 5, and Wall 6 Air Transfer Rates in Watts	37
Figure 37 – Wall 2 As-Built 62°C and 42°C Data.....	40
Figure 38 – Wall 2 As-Built 2°C and -18°C Data	41
Figure 39 – Wall 2 As-Built -28°C Data.....	42
Figure 40 – Wall 2 As-Built -18°C Infiltration/Exfiltration Data	43

2015-06-18 – Thermal Metric Summary Report (June 2015 Update)

Figure 41 – Wall 2 As-Built 42°C Infiltration/Exfiltration Data.....	44
Figure 42 – Wall 2 Sealed 62°C and 42°C Data	45
Figure 43 – Wall 2 Sealed 2°C and -18°C Data	46
Figure 44 – Wall 2 Sealed -28°C Data	47
Figure 45 – Common Thermal Metrics for Reference Walls 2, 7 and 8.....	52
Figure 46 – Measured Temperature Dependency for an R13 fiber glass Batt.....	53
Figure 47 – Measured Temperature Dependency of Selected Materials from the TM Research Project. 54	
Figure 48 – Predicted and Measured Assembly Wall R-values (air-air) for Wall 2 – Inset- R13 FG Batt....	54
Figure 49 – Measured Heat flows for Wall 2 – Inset R13 FG batt, ‘Sealed’	55
Figure 50 – Simple Conduction-Only Building Enclosure Heat Loss Model (i.e. no Air Leakage).....	56
Figure 51 – Measured Heat flows for Wall 2 – Inset R13 FG batt, ‘Sealed’ vs ‘As-built’	56
Figure 52 – Simple Building Enclosure Heat Loss Model with Discrete Air Leakage.....	58
Figure 53 – Measured Heat Flows vs Predicted Airflow Impact for Wall 2 – Inset R13 FG batt	58
Figure 54 – Simplified Building Model for Interaction given Equal Infiltration & Exfiltration	59
Figure 55 – Infiltration + Exfiltration Building Scenario for Wall 2 – Inset R13 FG batt	59
Figure 56 – Simplified Building Model for Interaction given Infiltration Only	60
Figure 57 – Infiltration Only Building Scenario for Wall 2 – Inset R13 FG batt	60
Figure 58 – Elevation of Framing & Electrical for Reference Wall 2 – Inset-Stapled F.G. Batt	63
Figure 59 – Vertical Section for Reference Wall 2 - Inset-Stapled F.G. Batt	63
Figure 60 – Elevation of Framing & Electrical for Reference Wall 3 – 2x4 Face-Stapled F.G. Batt	72
Figure 61 – Vertical Section for Reference Wall 3 – 2x4 Face-Stapled F.G. Batt	72
Figure 62 – Elevation of Framing & Electrical for Reference Wall 4 – 2x4 dsCFI	81
Figure 63 – Vertical Section for Reference Wall 4 – 2x4 dsCFI	81
Figure 64: Elevation of Framing & Electrical for Reference Wall 5 – ocSPF.....	91
Figure 65: Vertical Section for Reference Wall 5 - ocSPF.....	91
Figure 66: Elevation of Framing & Electrical for Reference Wall 5 II – ocSPF.....	100
Figure 67: Vertical Section for Reference Wall 5 II - ocSPF.....	100
Figure 64 – Elevation of Framing & Electrical for Reference Wall 6 – ccSPF	109
Figure 65 – Vertical Section for Reference Wall 6 - ccSPF	109
Figure 66 – Elevation of Framing & Electrical for Reference Wall 7 – 2x4 F.G. Batt with 1” XPS	118
Figure 67 – Vertical Section for Reference Wall 7 – 2x4 F.G. Batt with 1” XPS	118
Figure 69 – Elevation of Framing & Electrical for Reference Wall 8 – 2x6 F.G. Batt.....	127
Figure 70 – Vertical Section for Reference Wall 8 – 2x6 F.G. Batt.....	127

1 Introduction to the Thermal Metric Project

Energy-cost and security issues have generated demand for building enclosures that exhibit higher levels of thermal performance. The market has responded with new insulation products and building enclosure systems such as: various types of spray foam and spray-applied fibrous insulations, exterior insulated sheathing, Structural Insulated Panel Systems (SIPS), Insulated Concrete Forms (ICF), and Radiant Barrier Systems (RBS), and air sealing products etc. These new products and systems have prompted new discussion about the adequacy of R-value as a metric for the thermal performance of enclosure assemblies.

R-value has long been the industry standard for assessing the thermal performance of insulation materials. Building designers directly use R-value to describe the thermal performance of building enclosures. However, this practice does not account for a number of important factors: contemporary insulation materials and systems are more or less sensitive to thermal bridging; workmanship (i.e. quality of installation); and internal convection and through convection (i.e. infiltration, exfiltration, windwashing and re-entrant looping). The impact of such ‘anomalies’ and ‘defects’ is not captured in the standard (label and installed) R-value metric. There are a significant number of hours in the year when measured heat flow deviates considerably from the heat flow predicted by installed R-value. These realizations have generated an increased interest in the testing of envelope components against “real-world” conditions and in the development of a new metric for the thermal performance of building enclosures.

Building Science Corporation (BSC) assembled a team of industry partners with the goal of developing a new metric for the thermal performance of building enclosures that better accounts for known physical heat flow mechanisms (particularly natural and forced convection) and operating conditions.

1.1 Background

In 2007 BSC completed a report entitled “Review of the R-value as a Metric for High Thermal Performance Building Enclosures” that summarized the extensive existing research on heat flow through walls and highlighted physical mechanisms that are not usually included in codes and designer specifications. The impacts of thermal bridging and convective loops, although well understood, have not been sufficiently quantified to allow for prediction. Air infiltration and exfiltration through unsealed wall assemblies was identified as a major un-quantified heat flow mechanisms in the current approach to building enclosure thermal testing. From this review, a need was identified for measuring and rating heat flow across a wall under realistic temperature ranges (both cold and hot exterior conditions) and under the influence of air movement (both in and through the building enclosure).

BSC followed this work with a 2008 report entitled “Development of a Test Procedure and Apparatus for Measuring High Thermal Performance Walls” that outlined the requirements for a new metric for the thermal performance of building enclosures. New equipment and techniques, based on existing ASTM standards, were proposed.

1.2 Thermal Metric Partners

BSC assembled a consortium of six industry partners to participate in the privately-funded development of the new thermal performance metric and the associated test method:

- Dow Building Solutions
- Honeywell
- Huntsman Polyurethanes
- Icynene
- North America Insulation Manufacturer's Association (NAIMA)
- Greenfiber

A novel hot box apparatus was designed and constructed to permit the highly accurate measurement of heat flow under realistic operating conditions. Construction, commissioning, and calibration were completed between 2007 and 2009. Building Science Corporation (BSC) documented this work in the report “Building America High-R Enclosures Research Project: Construction, Commissioning & Calibration of a Novel Hot Box Apparatus for High-R Enclosure Performance Measurement”.

During 2010 a base set of walls developed within the partner group were tested at a private laboratory in Waterloo, Ontario, Canada. The report below briefly summarizes the work from 2007 to 2009 and compares and contrasts the testing results of six walls using 2x4 construction, one with 2x6 construction, five different stud cavity insulations, and one exterior insulation application. The focus of the base set of walls was to develop a set of reference values for the consortium to compare to in future testing using the new metric.

June 2015 Update: *When the original Thermal Metric Summary Report was released in October 2013 it did not include any test results for an open-cell spray polyurethane (ocSPF) reference wall assembly. An ocSPF reference wall was prepared but the contractor-installed insulation was problematic and deemed unacceptable. Researchers completed testing of that wall but it was not included in the October 2013 report. Through 2014 and early 2015 a second ocSPF reference wall assemblies was prepared and tested. The results for both ocSPF assemblies are reported in Section 3.5 of this report.*

Researchers have also completed testing of a number of proprietary walls; wall assemblies selected by individual industry partners in support of investigative or demonstrative testing. Appendix A includes test results for two of the proprietary walls: one R15 fiber glass batt-insulated wall, and one dense-packed fiber glass insulated wall, both with a focussed air sealing package (caulked joints between all framing elements and the structural sheathing).

1.3 Thermal Metric Test Apparatus

This section of the report provides a summary of the construction and operation of the apparatus as context for later discussion on commissioning and calibration.

In general the test apparatus has been designed and constructed in accordance with ASTM C1363, “Standard Test Method for Thermal Performance of Building Materials and Envelope Assemblies by Means of a Hot Box Apparatus.” A number of modifications were made to meet the specific objectives of the research.

The key improvements over conventional hot box testing are the ability to test higher R-value enclosure assemblies (which have lower heat fluxes), the ability to expose enclosure wall samples to realistic temperature differences while maintaining the interior temperature at normal room temperatures, and the ability to measure the impact of imposed airflow at a given pressure difference across the specimen in both directions.

1.3.1 Conventional Hot Boxes

ASTM C1363 recognizes two configurations for a hot box test apparatus: guarded and calibrated. A conventional guarded hot box apparatus comprises three boxes: the climate box, the meter box and the guard box. The wall test specimen is installed between a climate box and a meter box so that the interior side of the wall faces the meter box and the outside of the wall faces the climate box. In a conventional guarded hot box, the test wall specimen is larger than the opening of the meter box. The meter box walls taper to a thin edge. This thin edge is in contact with and seals against the face of the test wall specimen. When the temperatures in the guard box and the meter box are equal, all of the heat flow at this interface is perpendicular to the plane of the wall so there is no “flanking loss”.

The climate box is typically cooled to maintain a temperature of 50 or 55°F (10 or 12.8°C) and a measured amount of heat is added to the meter box to maintain a temperature of 95 or 100°F (35 or 37.8°C) so that the average temperature across the test wall specimen is 75°F (23.9°C). Air is typically heated and circulated through the space between the guard box and the meter box to minimize the temperature difference (ΔT) between the meter box and guard box, and therefore the heat flux across the meter box wall, so that any heat added to the meter box must be flowing through the test wall specimen.

Most conventional hot boxes have design limitations which only allow them to operate within a small temperature range. Temperatures in the climate box and the meter box are often not representative of real climate and room temperature conditions. Few meter boxes are equipped with the ability to provide any measured cooling. This means that hot weather (i.e. cooling climate) tests must be run well above the temperature of the laboratory (calibrated boxes only) or the specimen must be removed from apparatus and turned around so the cladding side (i.e. outside) of the wall faces into the meter box while the drywall side (i.e. inside) faces the climate box. This means that the testing must be disturbed to reverse the temperature differential over the specimen.

1.3.2 Thermal Metric Research Hot Box

For the purposes of the Thermal Metric (TM) research project a novel hot box apparatus was designed and constructed. The apparatus, depicted by the schematic in

Figure 1, was based as closely as possible on ASTM C1363, however a number of improvements were made to facilitate the research. These include:

- A deeper meter box to permit the testing of wall-wall and wall-floor intersections at full scale
- Metered equipment to both heat and cool the meter box
- Draw-through fans to create more realistic airflow over the inside surface of the wall specimen
- A double guard (insulated guard box + liquid guard loop) to improve control over the temperature differential across the meter box walls and minimize uncertainties
- A modified specimen frame or ‘cartridge’ to control flow of heat and mass at the perimeter of the metered area of the test wall specimen
- An air transfer system to induce infiltration / exfiltration

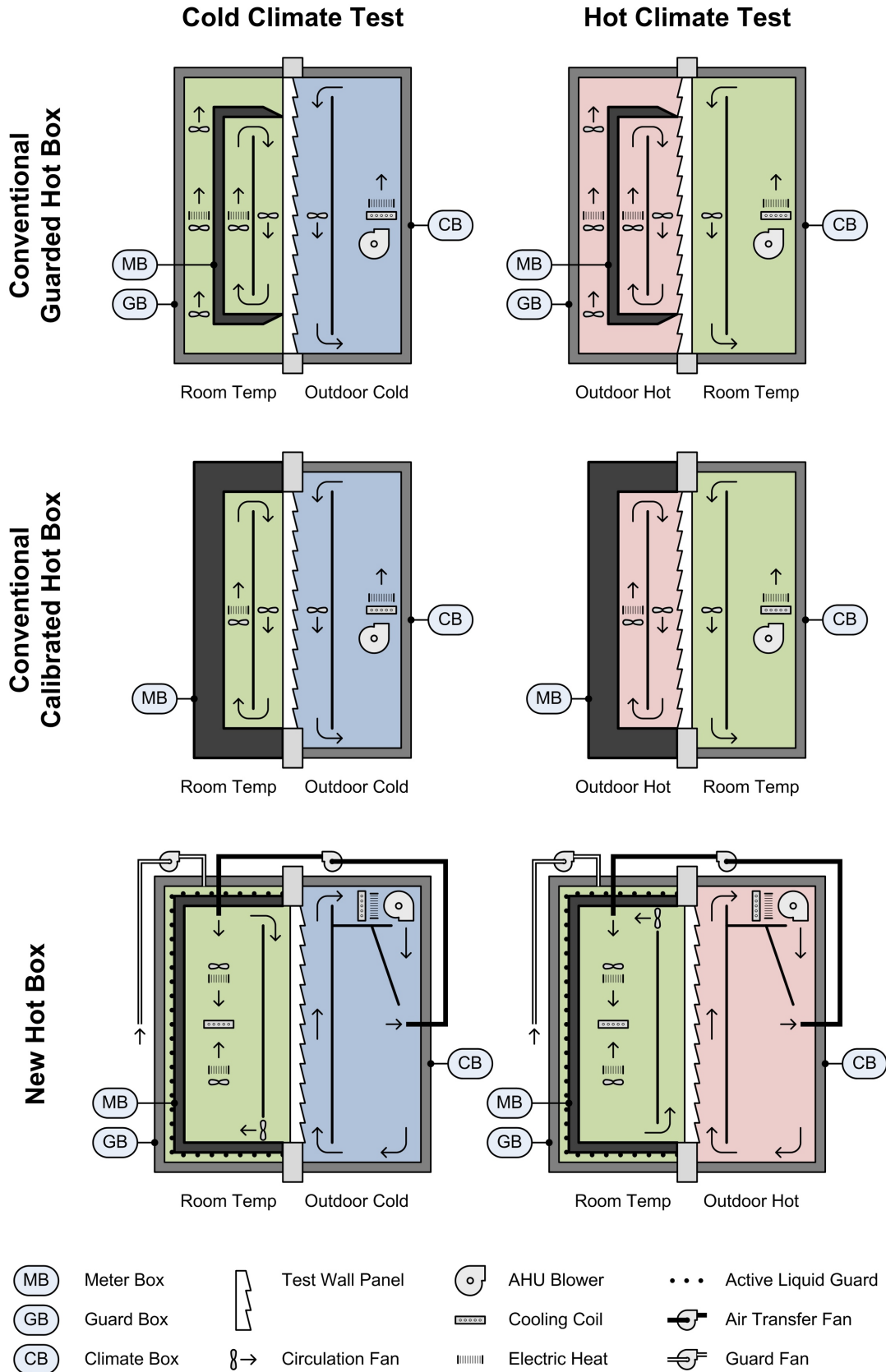

Figure 1 – Schematics of Conventional Guarded Hot Box (top), Conventional Calibrated Hot Box (middle) and Thermal Metric Research Hot Box (bottom)

General Construction Details

The walls of the TM hot box are custom-assembled structural insulated panels comprising 7/16 in. (11 mm) plywood adhered to either side of a solid layer of 4 in. (100 mm) XPS insulation to create a stiff, strong, airtight wall with an unbridged, continuous thermal resistance of more than R21 (RSI 3.7). These SIPs are attached to the inside of a steel exoskeleton using fasteners that only penetrate the outer layer of plywood.

Meter Box

The meter box walls are insulated with an additional R10 (RSI 1.76) of foil-faced insulation. The foil acts as an isothermal surface to which to fasten temperature sensors, and as a low emissivity surface that ensures a uniform radiant exposure behind the insulated air baffles.

The insulated baffles are used to form consistent vertical airflow patterns over the interior faces of the test wall specimen. The baffles consist of RSI 0.88 (R5) insulation boards with a low emissivity foil skin facing the inside of the meter box and a painted plastic skin facing the wall specimen. The low emissivity foil skin and the insulation ensure that the baffle is at a constant temperature close to that of the air that is travelling across the face of the test wall specimen. The painted plastic skin ensures that the surface of the test wall specimen radiates to the baffle as a real wall would to its surrounding environment. Calibrated precision thermistors $\pm 0.2^{\circ}\text{F}$ ($\pm 0.1^{\circ}\text{C}$) are used to measure temperatures at 24 points on the baffle surface, 24 corresponding points in the air stream, and 24-36 points on the interior surface of the wall test specimen.

Airflow in the baffle space is induced by a set of DC axial circulation fans at the top or the bottom of the baffle. The fan speed can be adjusted to draw the air through the baffle space at velocities representative of natural convection in real world conditions, typically 1fps (0.3 m/s). The lower fans are used to draw air in and down the wall during cold climate tests while the upper fans are used to draw air in and up the wall during hot climate tests. The use of draw-through fans ensures that velocities over the test wall specimen are uniform and the flow is more laminar. The voltage and current to the circulation fans are measured across precision ($\pm 0.01\%$) resistors so that the power may be calculated.

The temperature in the meter box is controlled by electric heat and hydronic cooling. Two heating arrays, each consisting of 16 heaters and 8 mixing fans, are installed in the upper and lower portions of the mixing part of the meter box as seen in Figure 2. The size, number and distribution of the heaters and fans ensure that the temperature is relatively uniform throughout the meter box. Again, voltage and current supplied to the heaters and mixing fans are measured across precision ($\pm 0.01\%$) resistors so that the power may be calculated.



Figure 2 – Upper and Lower Heating Arrays with Cooling Coil in Meter Box

Cooling is achieved by a large, finned convection coil mounted at mid-height in the mixing part of the meter box. The large heat transfer area permits the removal of significant amounts of heat with only modest (e.g. 1°C or 1.8°F) temperature increases across the coil. Distilled water is pumped from a chilled, constant temperature ($\pm 0.05^{\circ}\text{C}$) buffer tank, into the meter box, through the convection coil, and back out of the meter box. The flow rate is measured using a NIST traceable $\pm 0.2\%$ of reading flow meter and the supply and return temperatures are measured using a pair of precision thermistors ($\pm 0.1^{\circ}\text{C}$) and a pair of ultra-precision RTDs ($\pm 0.012\text{ohm}$). These measurements can then be used to calculate the power extracted by the cooling.

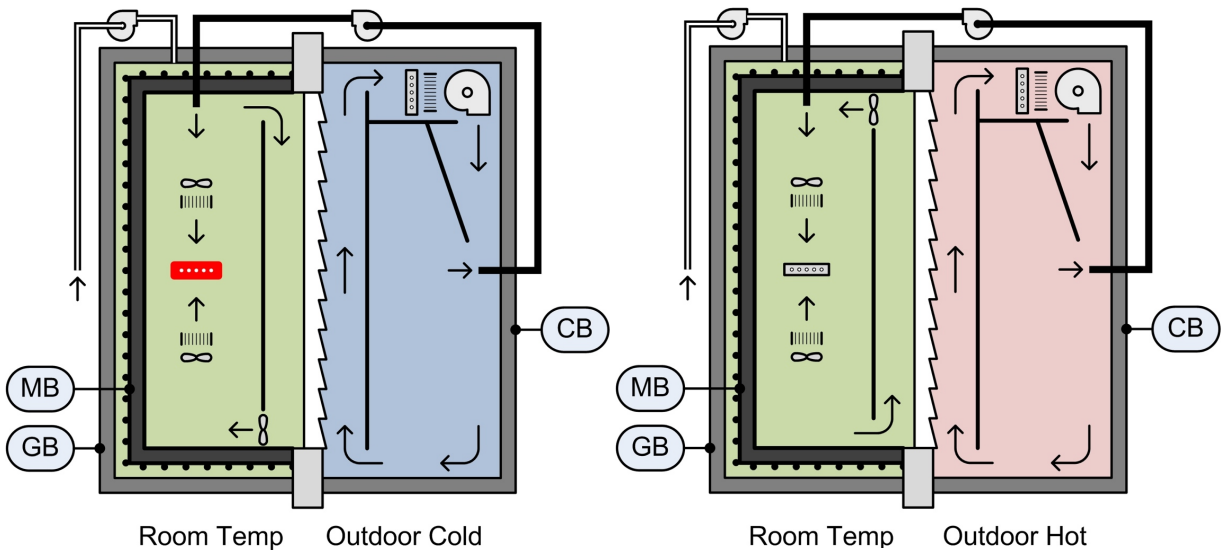

Figure 3 – TM Hot Box Schematic in Cold Climate mode (left) and Hot Climate mode (right)

The Double Guard

The TM hot box employs a double guard: an insulated guard box surrounds the meter box and a hydronic (liquid) guard loop is installed over the outside surface of the meter box as seen in the photograph of Figure 5. The guard box minimizes the influence of temperature changes in the laboratory and reduces spatial temperature gradients over the surface of the meter box. The liquid guard loop further reduces any spatial temperature gradients and all but eliminates any temperature difference between the inside and the outside of the meter box walls.

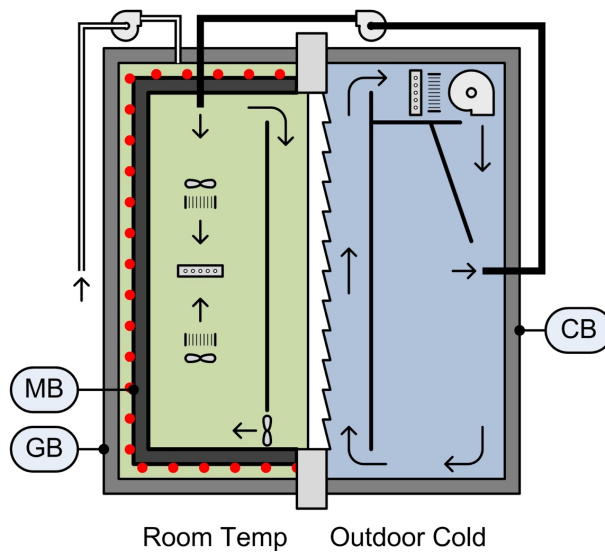

Figure 4 – TM Hot Box Schematic indicating Active Liquid Guard

The temperature difference is measured by paired precision thermistor arrays that are applied to the inside and outside of each of the five faces of the meter box at a density of more than 5 sensors per ten square feet. In all, the temperature difference is measured at 176 locations. The hot box control system uses the aggregated differential temperature measurements to control the guard loop supply

temperature to reduce the average temperature difference across the meter box walls to less than 0.09°F (0.05°C).

Each of the guard loops can be individually controlled with metering valves to allow the flows to be calibrated from time to time to ensure spatial uniformity of the temperature. The water flow of each loop has been designed to absorb or release the expected heat flow through the R20 guard box walls (in the range of 2 to 4 W per loop) with a temperature rise of less than 0.009°F (0.005°C).



Figure 5 – Double Guard: Guard Box (Left) and Liquid Guard Loop on Meter Box (Right)

Climate Box

The climate box has the same dimensions and construction as the guard box. The climate side air baffles are constructed using the same materials and methods as the air baffles in the meter box. Foil-faced insulation is also used to form the return plenum at the ceiling and the supply plenum that runs half way down the back wall of the climate box. The temperature in the climate box is controlled by a series of four fan coils connected to an air-cooled liquid chiller, a hydronic heater, and relay controlled electric resistance heat.

The Wall Cartridge

Section 6.7.1 of ASTM C1363 requires the provision of a specimen frame to support the wall test specimen in position between the meter box and climate box and to insulate the perimeter of the specimen to reduce flanking losses. In a conventional guarded hot box, the wall test specimen area extends beyond the perimeter of the meter box so that the portion of the wall that is between the meter box and the climate box see the same heat flow as the portion of the wall that is between the guard box and the climate box. This is an extremely effective method of minimizing flanking losses; however, when hollow (e.g. framed) walls are tested, it provides paths for air to flow not just between

the climate box and the meter box, but also between these two boxes and the guard box. The interaction between heat and airflow is of particular interest in the Thermal Metric research program, hence the team felt it necessary to design a specimen frame that would not only minimize flanking losses, but also eliminate airflow outside of the area of the wall test specimen.

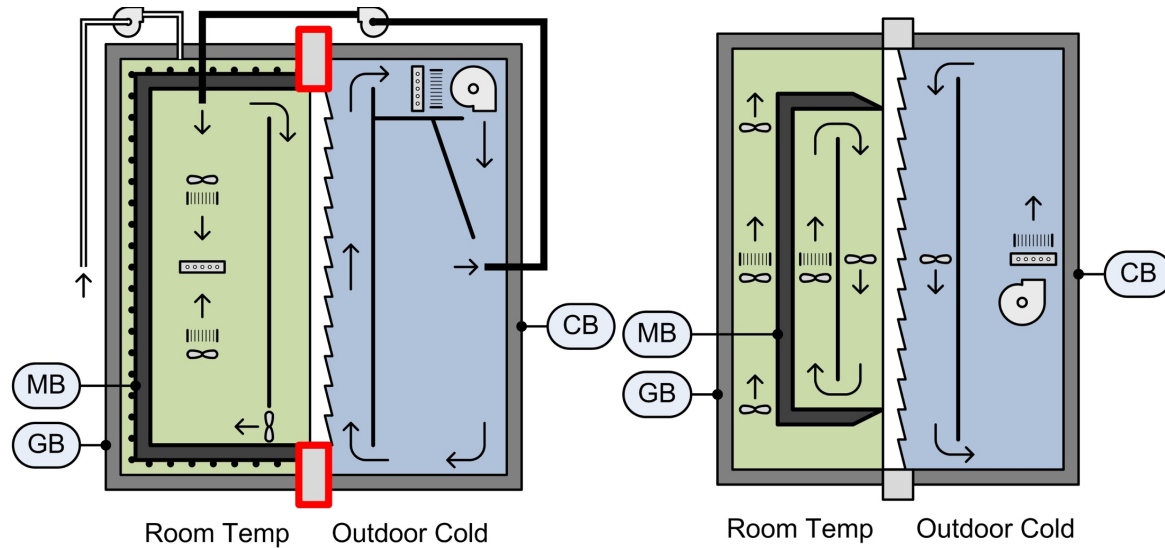

Figure 6 – TM Hot Box Schematic indicating Cartridge (left) and Conventional Guarded Hot Box Schematic (Right)

The TM hot box specimen frame or ‘cartridge’ comprises alternating layers of 7/16 in. (11 mm) plywood and 4 in. (100 mm) XPS foam board glued up to create an exceptionally stiff sandwich panel as seen in Figure 7. Two 2 x 2 in. (38 x 38 mm) nailers are embedded in the cartridge to provide fastening support. A 4 in. (100 mm) thick XPS thermal break lines the entire rough opening of the cartridge so that the finished opening and the size of the wall test specimen match the meter box opening: 12 ft wide by 8 ft high (3.66 m x 2.44m).

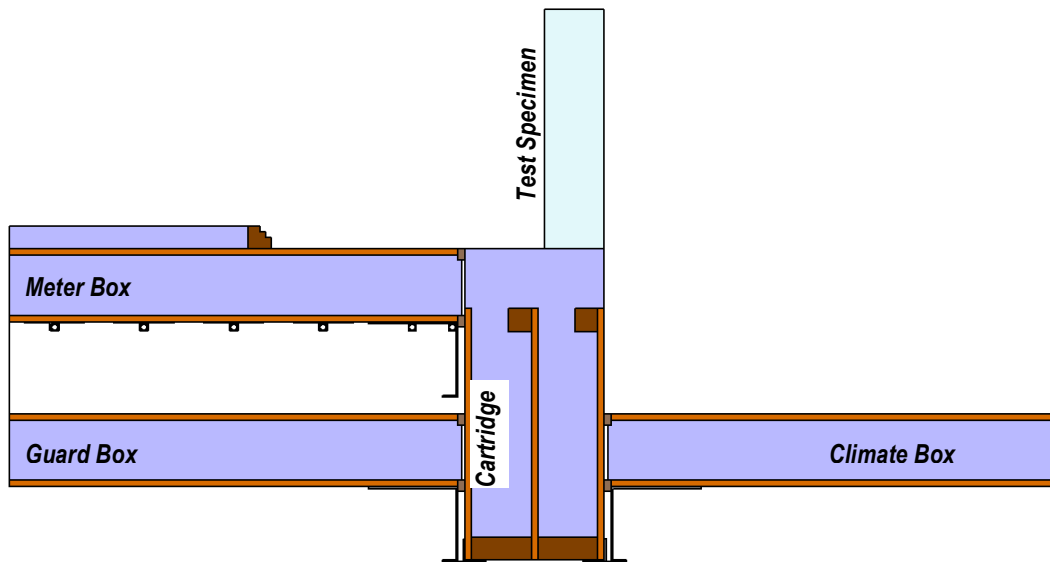

Figure 7 – Section through Wall Cartridge with Meter, Guard and Climate Boxes in Position

The wall test specimen is positioned so that its cladding is in plane with the climate side of the wall cartridge. The geometry allows space for air in the climate box to turn the corner and regain uniformity before it passes over the surface of the wall test specimen. This is important when considering the interaction between heat flow and airflow. The arrangement does however complicate the flanking loss because there is a portion of the cartridge that is exposed to the meter box yet is not guarded (i.e. that portion of the thermal break that lies between the inside face of the drywall and outside of the meter box gasket). Steady state 2-dimensional heat flow analysis was conducted using HEAT2 to optimize the wall cartridge design and to reduce flanking losses so that they were comparable to those in hot boxes operated by the industry partners on the Thermal Metric research team.

Figure 8 shows the temperature distribution and heat flux vectors acting across the wall cartridge for a meter box temperature of 22°C (71.6°F) and a climate box temperature of -18°C (0.4°F).

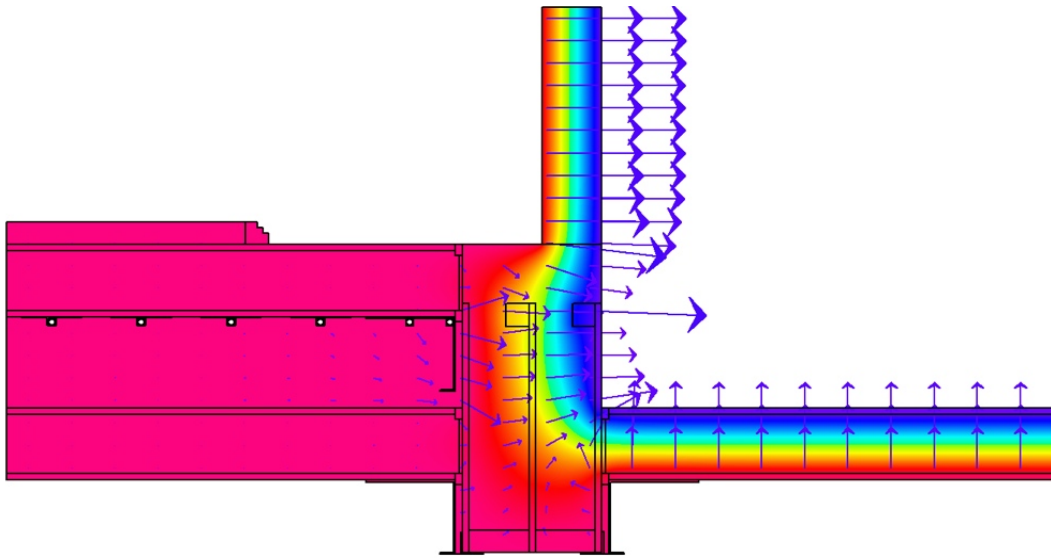

Figure 8 – Temperatures & Heat Flux at 22°C (71.6°F) Meter Side & -18°C (0.4°F) Climate Side

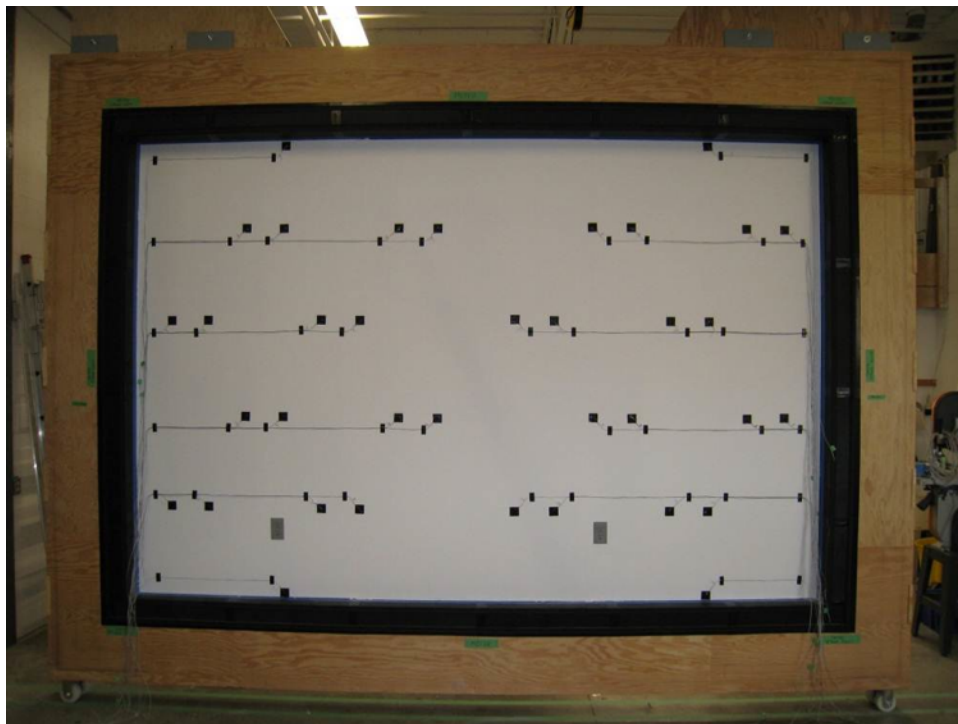

Figure 9 – Wall Cartridge with Test Wall Specimen Installed & Instrumented for Testing

1.3.3 Air Transfer System

One of the novel aspects of the TM hot box is the air transfer system (ATS). The system, pictured in Figure 11, generates a pressure difference between the meter box and the climate box to drive airflow through available paths in the test wall specimen. The system comprises an inline variable-speed DC blower, an inline heater, three high-accuracy ($\pm 2\%$ of reading) mass flow sensors and piping and valves to allow researchers to negatively pressurize (i.e. induce infiltration) or positively pressurize (i.e. induce exfiltration) the meter box. A variable-speed DC guard fan with similar valves is used to minimize the pressure difference between meter and guard boxes so that airflow only occurs between the meter and the climate boxes.

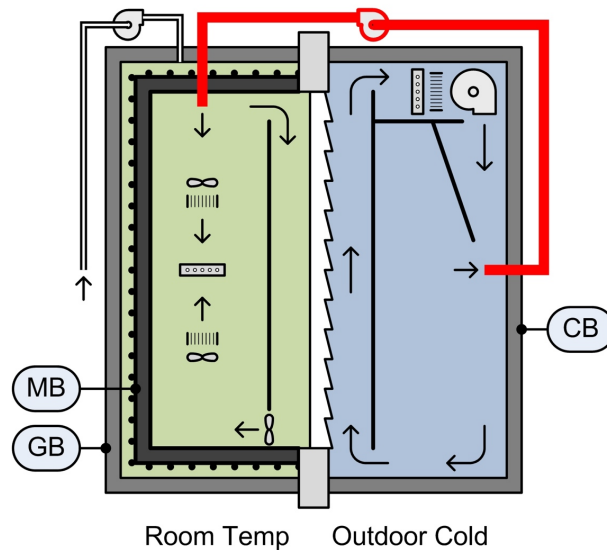

Figure 10 – TM Hot Box Schematic indicating Air Transfer System

The ATS must be able to supply the air required in the testing protocol. Two versions of each wall are tested: an “as-built” version and a sealed version. The as-built walls incorporate imposed, repeatable gaps and leakage paths within the wall. The sealed walls are sealed on both sides with polyethylene sheets (i.e. over the GWB on the inside and the cladding on the outside). Each of these wall types is discussed in more detail in the following section. Typical flow rates for the as-built walls are expected to be in the range of 2 to 50 cfm at pressures of 2 to 25 Pa, imposing leakage rates of 0.02 to 0.50 cfm/ft². The goal for the sealed walls is to reduce this leakage by more than 90 percent to significantly reduce the impact of airflow through the specimen. For all of the testing completed within this report, where an air pressure was imposed, it was imposed at 10Pa, as decided by BSC and the industry partners.

Heat transfer associated with the airflow is calculated using the measured flow rate, the heat capacity of air at the measured pressure, temperature and humidity, and the temperature difference between the delivered air temperature and the air temperature in the meter box (measured using an array of precision thermistors @ $\pm 0.1^\circ\text{C}$).

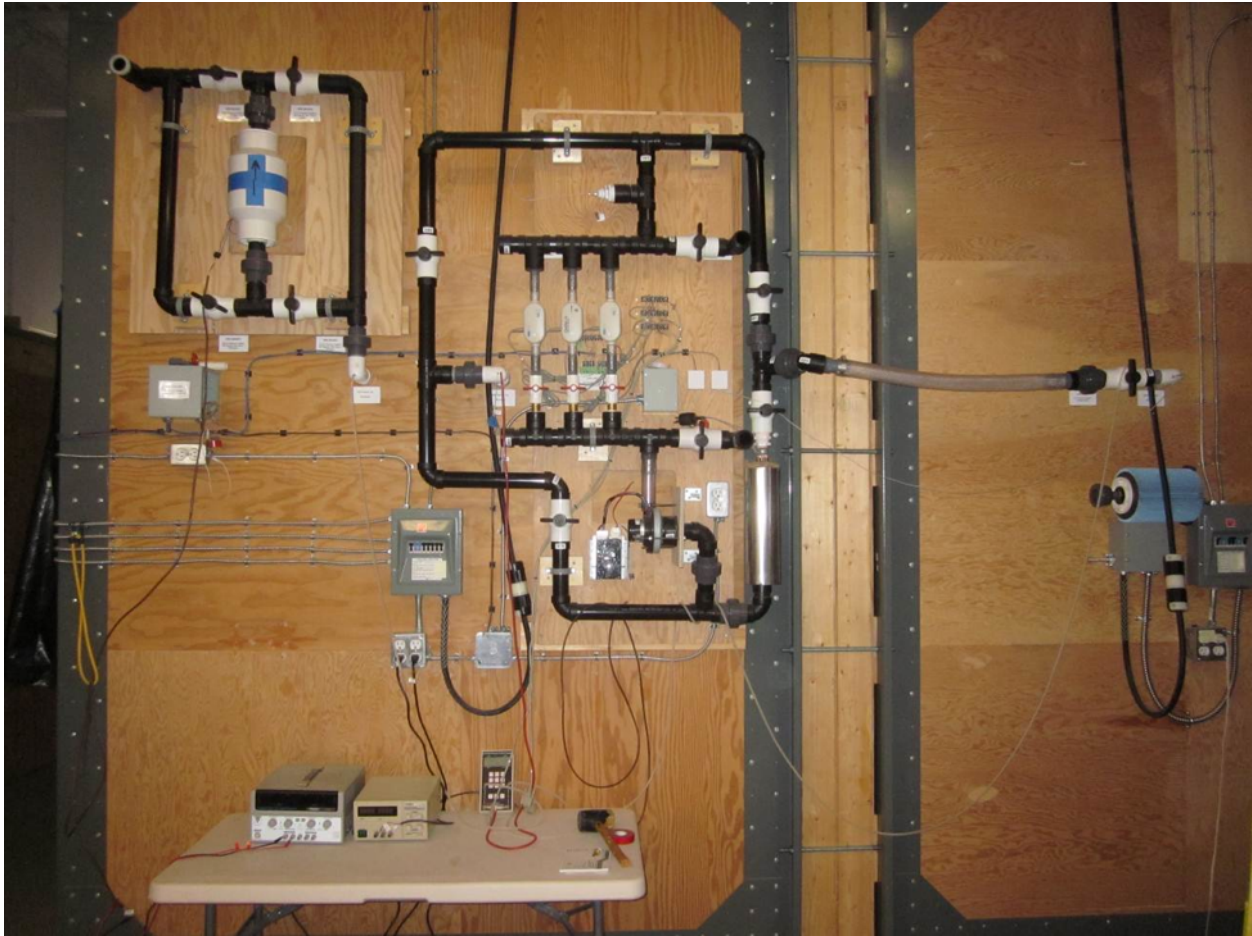

Figure 11 – Guard Fan (Left) & Air Transfer System (Center)

As-Built and Sealed Wall Assemblies

In order to ensure the tests are comparable in terms of air leakage, a representative, repeatable and reliable method to create leakage paths through each wall assembly is required. The first requirement is that the leakage be representative of real world assemblies. Initial laboratory-built walls were very airtight, even when intentional gaps were installed. This led to the necessity to compare a variety of spacers and spacer locations in order to attain a representative and repeatable imposed gap. The walls containing spacers designed to reproduce air leakage paths commonly found in walls are referred to as “as-built” walls in this report.

As-Built Test Assembly

A simple wall assembly was built to determine the shim thickness required to attain a desired airflow rate. Industry airflow rates and requirements are shown in Table 1 for reference.

Table 1 – Industry Airflow Rates

Source	Requirement	Notes
IRC	Substantially air tight	
GSA	0.04 cfm50/ft ²	Assembly
ASTM1677	0.045 cfm50/ft ²	Assembly
Bldg. America	0.25 cfm50/ft ²	Whole enclosure
EnergyStar	0.2 cfm50/ft ²	Whole enclosure
Wall Label	Measured	Notes
Lab Test Walls	0.015 to 0.022 cfm50/ft ²	
Leaky Attempt	0.162 cfm50/ft ²	

The wall to test airflow rates was built as follows:

- ½” drywall
- 2x4 framing at 16” on centre
- Fiber glass batt insulation installed to HERS grade I
- 7/16” OSB sheathing
- Tyvek housewrap (single piece, no laps)

Both the OSB and drywall at the top and bottom plates were held away from the plates with spacers of a known thickness. The spacers were installed to ensure that the fasteners went through a hole in the spacer (and not between the spacers) to ensure an even gap was developed between the fastener locations by the spacers. The initial spacers were made from 1” wide and 1/16” thick aluminum stock. The spacers were cut and a hole drilled through for the fastener. The fasteners were installed in the OSB as per the OSB sheathing requirements and a spacer was installed at every fastener on the top and bottom plates. A mid-height horizontal 1/8” gap was built into the sheathing.



Figure 12 – 1/16" Aluminum Stock Spacer



Figure 13 – Spacer Installation

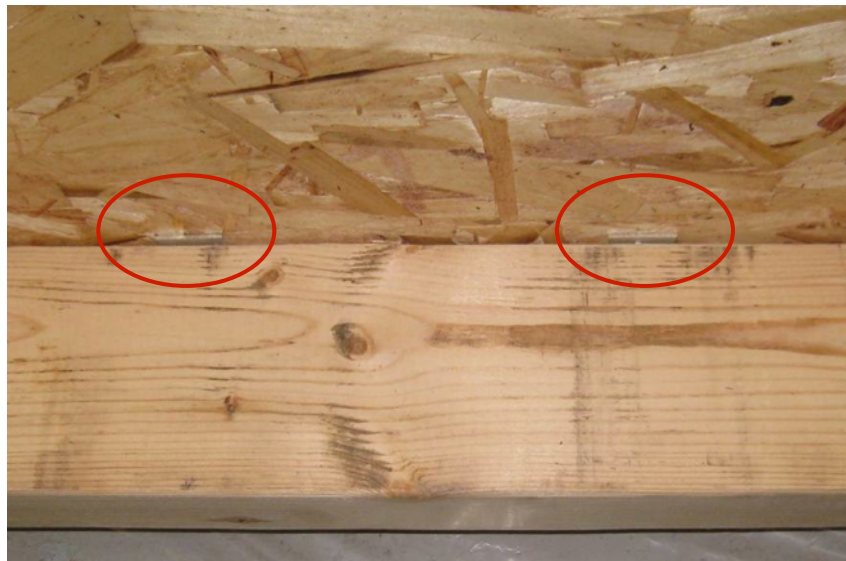

Figure 14 – Installed Bottom Plate Spacers

Two un-gasketed electrical outlets and a switch were installed as penetrations through the drywall. Standard 14/2 wiring was installed between the plugs and the switch and was drilled horizontally

through the necessary studs with a 5/8" drill bit. This creates air leakage paths between the stud bays within the assembly.



Figure 15 – Electrical Installed and Horizontal Gap Visible

The fiber glass batt was installed in the stud bays to HERS grade I specifications. The two spacers next to one another in Figure 16 are at the point at which two sheets of drywall meet and the corner of both sheets require support.



Figure 16 – Drywall Spacers and Fiber Glass Batt Installed

A single continuous sheet of spun-bonded polyolefin (SBPO) housewrap was stapled to the exterior of the wall and was taped on the sides only. Taping on the sides only ensures that air that exits at the mid-height of the sheathing at the imposed gap has a route to escape past the housewrap. This is an expected leakage path for air in an actual wall assembly.



Figure 17 – Tyvek Installed but Untaped

The drywall was installed with spacers on the top and bottom plates just as the OSB was installed. The last vertical stud on each end of the 8' x 12' assembly was sealed to the drywall with a gasket to ensure a leakage path was not provided at the ends of the wall. The vertical edges of the air barrier were sealed to simulate a continuous wall.



Figure 18 – Drywall Installed

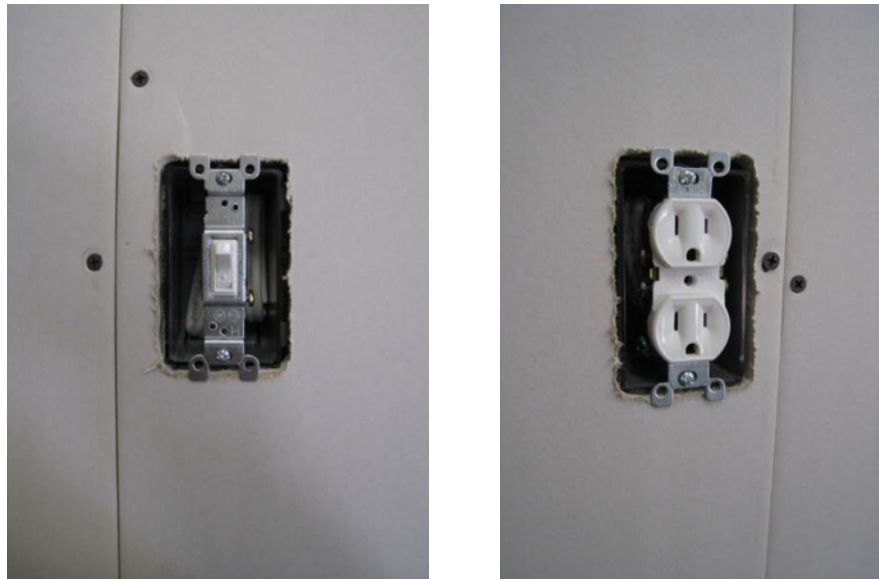

Figure 19 – Installed Switch and Plug

Upon air leakage testing the initial wall it was found that the leakage was too high compared to the data found in the literature review. The wall was disassembled and the 1/16" spacers were replaced on the drywall side with 1/32" spacers (Figure 20). The air leakage test was run again, and it was determined the leakage was still above the acceptable bounds. The OSB was removed and the 1/16" spacers were replaced with 1/32" spacers. The air test was run again and this provided acceptable air leakage rates.

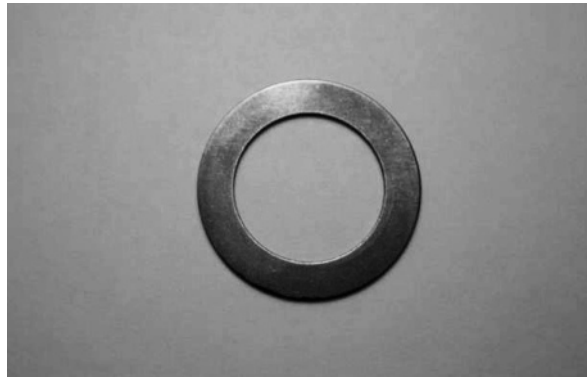

Figure 20 – 1/32" Wall Spacers

The results from the air leakage summary are shown in Figure 21. The analysis shows that with 1/32" spacers installed between both the drywall and the top and bottom plates as well as the OSB and the top and bottom plates an air leakage rate of approximately 0.25 CFM50/ft² is attained. This method of creating air leakage paths at the top and bottom plates was used for all of the walls discussed within this report.

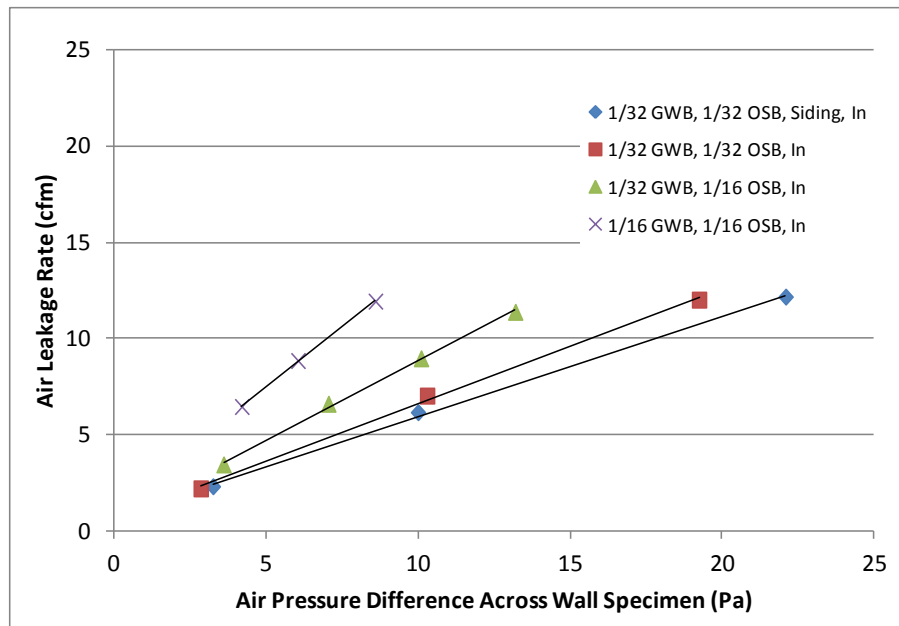

Figure 21 – Imposed Gap Analysis

Sealed Test Assembly

For the standard protocol developed by the Thermal Metric team, testing is completed on the as-built assembly and then the cartridge holding the wall is removed from the Thermal Metric box. Both sides of the wall are then sealed to the cartridge with a single sheet of polyethylene to create an air barrier on both sides of the assembly. This not only limits air leaving or entering the meter box through the assembly but also prevents air from entering on one side of the assembly and escaping on that same side due to differential pressures caused by stack effects or fan interactions. The typical sealed wall assembly was found to have an air leakage rate of approximately 0.06 to 0.10 CFM50/ft², less than 1/20th that of its as-built assembly. Sealed spray foam assemblies achieved the same level of airtightness as the other sealed assemblies, but the ratio from as-built to sealed was smaller. The air leakage rates during each test are discussed further in the data analysis section of this report.

Sealing of the test wall requires the application and attachment of a continuous sheet of polyethylene on both sides of the wall. A clear polyethylene was chosen to limit changes to the wall surface from radiation. A mid-weight polyethylene was chosen because lightweight polyethylene was difficult to tape in place and heavyweight polyethylene is generally less translucent. The wires for the thermistor sensors had to penetrate the polyethylene, so a method was developed to air seal the penetration. Figure 22 and Figure 23 show the method of air sealing the thermistor sensor wires as they penetrate the polyethylene air seal. A conforming foam double-sided tape is applied to both sides of the slit in the polyethylene and then a double layer of heavy duty tape covers the whole assembly. Figure 24 and Figure 25 show the air sealing of the meter box side of the wall, while Figure 26 and Figure 27 show the air sealing of the climate box side. Thin double-sided tape is used on each sensor location, and slightly thicker double-sided tape is used to create a grid of adhesive locations between the sensors. A double-sided tape seal, seconded with heavy duty tape, creates the perimeter seal.

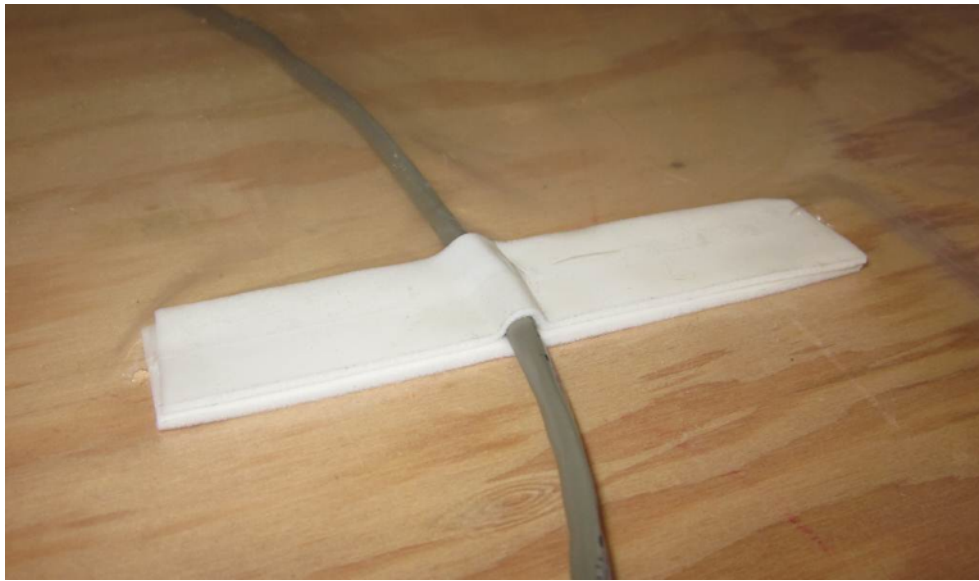

Figure 22 – Sealed Wall Wire Penetration

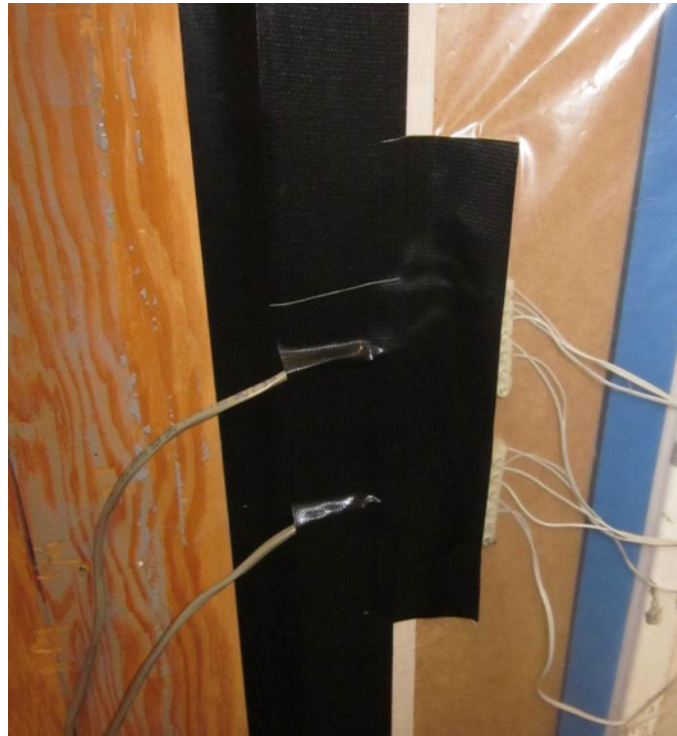

Figure 23 – Final Wire Seal with Double Tape Layer



Figure 24 – Meter Box Side, Grid of Double-Sided Tape



Figure 25 – Meter Box Side, Polyethylene Installed



Figure 26 – Climate Box Side, Tape Grid



Figure 27 – Climate Box, Polyethylene Installed

1.3.4 CO₂ Tracer Gas System

In order to quantify the heat flow due to air transfer through an assembly throughout the testing period a method of continuously monitoring the airflow through the assembly was required. A tracer gas system was assembled using CO₂ injection port in the meter box and monitors within the meter box and climate box. Atmospheric CO₂ is approximately 400 parts per million (ppm) and can be easily monitored with readily available components for building HVAC automation equipment. As a process, the meter box is first injected with CO₂ gas to a concentration approaching 10,000 ppm while the climate box begins closer to atmospheric levels. As the test progresses, depending on the leakiness of the assembly, the CO₂ transfers from the meter box to the climate box. The monitoring system takes a temperature-corrected reading every minute in both spaces. A data logger collects and stores the information. The data can then be downloaded and, using a mass balance equation comparing readings simultaneously in both spaces, the air transfer between the spaces can be calculated. A third CO₂ sensor monitors the laboratory space next to the box for comparison. Figure 28 shows the decay for a test wall showing the decay of the meter box CO₂, the climb of the climate box CO₂ and the correlating CFM of air leakage on a 10 minute average plotted on the right-hand axis. Using a 10 minute running average decay comparison (30 minute for sealed tests as the decay is much slower), the actual airflow is calculated. The 10 minute averages are averaged over a selected period to determine the air leakage for each set point.

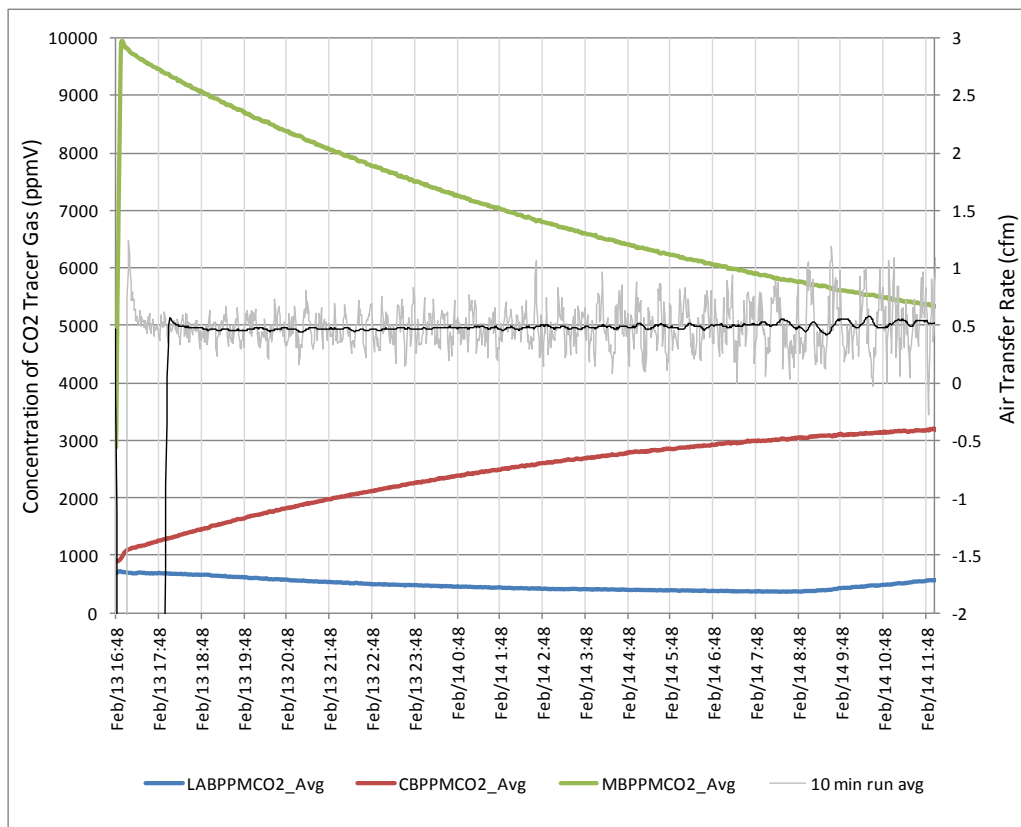

Figure 28 – Tracer Gas Decay and Mass Flow

2015-06-18 – Thermal Metric Summary Report (June 2015 Update)

During the transition between set points a compressed air system with a paired air dryer is used to dilute the CO₂ in the climate box to below 1000 ppm. Dry air is pumped into the climate box as the air within the climate box is drawn out by the air transfer system limiting the pressure differential over the specimen and the climate box walls. As the dilution is occurring the dry air is also helping to ensure there is minimal humidity within the meter box and climate box spaces. Once the temperature transition to the next point has occurred, typically after 3-6 hours, the air transfer system and compressor are shut down. As the box approaches equilibrium, the meter box is injected with CO₂ again to 10,000 ppm and the decay curves are again monitored. In the case of the sealed assembly there is so little decay to the climate box that only one injection to the meter box is required at the beginning of the testing. The decay curve for the sealed test is broken down by test date to calculate the decay during each temperature set point.

1.4 Test Specimen Construction

Each of the reference wall test specimens started from the same basic wall frame with 1/32” machined spacers to create gaps between the plates (top and bottom) and the OSB and drywall. Air sealing and insulation strategies were implemented in accordance with industry best practices and manufacturer’s recommendations. The general construction details are provided in this section of the report. Specific details, schematics, photos and notes are provided in the results section for each reference wall (Section 3 of the report).

Overall Size

Nominal Size - 96” x 144” (2477mm x 3658mm)

Actual test specimen dimensions - 95” x 143 1/8” (2413mm x 3635mm)

Wall Thickness – Up to 10” (25.4mm)

Assembly Details

Table 2 contains the details for each tested reference wall. All of the walls are 2x framed at 16” on center. Walls 2 through 7 were framed with 2x4. Walls 2 and 3 were fitted with kraft-faced fiber glass batts, Wall 4 was full-filled with damp sprayed cellulose, Wall 5 was full-filled with open-cell spray polyurethane foam, Wall 6 was filled with approximately 2” thick closed-cell spray polyurethane foam, and Wall 7 was fitted with fiber glass batt and 1” of exterior XPS. Wall 8 was a 2x6 frame wall fitted with R21 fiber glass batt.

Table 2 - Wall Specimen Details

Wall Label	GWB Sealing	Frame	Electrical Outlets	Cavity Insulation	Insulation R-Value ¹	Sheathing Sealing	Exterior Insulation	Cladding
Ref Wall 2 Inset R13 kraft FG	Sealed only on sides	2x4 16”oc	Cut in GWB (taped)	R13 inset-stapled kraft-faced fiber glass batt	13	Sealed only on sides	no	Vinyl siding
Ref Wall 3 Face R13 kraft FG	Sealed only on sides	2x4 16”oc	Cut in GWB (taped)	R13 face-stapled kraft-faced fiber glass batt	13	Sealed only on sides	no	Vinyl siding
Ref Wall 4 dsCFI	Sealed only on sides	2x4 16”oc	Cut in GWB (taped)	Full-fill, scrubbed Damp sprayed cellulose	13	Sealed only on sides	no	Vinyl siding
Ref Wall 5 ocSPF	Sealed only on sides	2x4 16”oc	Cut in GWB (taped)	Full-fill, scarfed 0.5 pcf ocSPF	12.6	Sealed only on sides	no	Vinyl siding
Ref Wall 6 ccSPF	Sealed only on sides	2x4 16”oc	Cut in GWB (taped)	2” thick 2 pcf cc SPF	12	Sealed only on sides	no	Vinyl siding
Ref Wall 7 R13 FG + R5 XPS	Sealed only on sides	2x4 16”oc	Cut in GWB (taped)	R13 unfaced fiber glass batt	13+5=18	Sealed only on sides	1” XPS	Vinyl siding
Ref Wall 8 R21 FG batt	Sealed only on sides	2x6 16”oc	Cut in GWB (taped)	R21 unfaced fiber glass batt	21	Sealed only on sides	no	Vinyl siding

1) Nominal installed R-values based on labeled R-value for fiber glass batt and XPS board insulation materials. Nominal installed R-values based on installed thickness and average of published (<http://energy.gov/energysaver/articles/insulation-materials>) R-value / in. for blown (CFI) and sprayed (ocSPF and ccSPF) insulation materials. The actual installed R-value can be slightly higher or lower as it is affected by density, pore structure, voids, gaps, variations in insulation thickness, etc., depending on the type of material and quality of installation.

Temperature Measurement Locations

Paired temperature measurements are made on opposite sides of each specimen using calibrated thermistors. Each temperature measurement location on the meter box side correlates to a temperature measurement location on the climate box side. The thermistors are attached directly to the surface of the specimen using a three layer taping assembly including a black low emissivity top tape layer to limit interaction effects of neighboring surfaces. Figure 29 shows an instrumentation grid typical of the walls tested. Stud, stud bay, and top and bottom plate temperatures are measured and averaged.

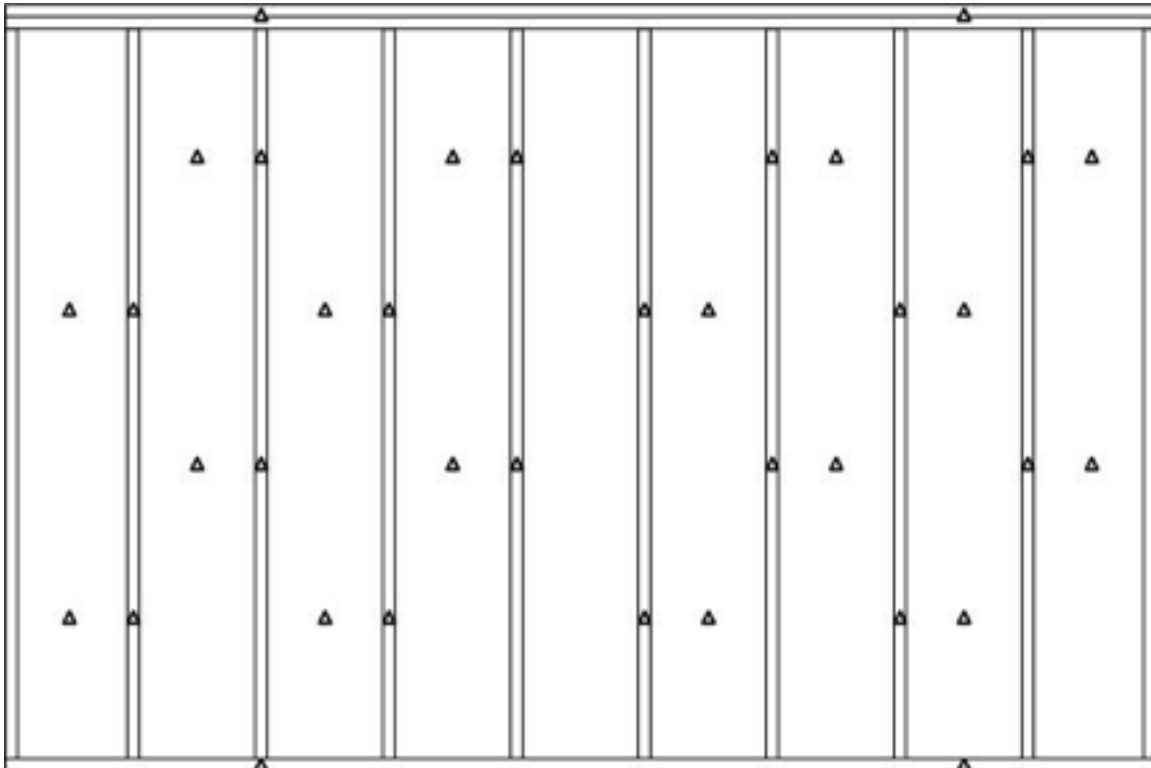

Figure 29 – Temperature Measurement Locations

Construction and Installation Process

The following process depicts a normal construction process for each test wall.

1. Framing materials are chosen from a selection of moisture content equilibrated framing lumber of similar average densities.
2. The 95 in x 143 1/8 in (2410 mm x 3635 mm) stud wall is framed on a level surface without affixing the sheathing.
3. Two heavy beads of removable caulking are placed on the cartridge below the location of the bottom plate for air sealing purposes.
4. The wall is lifted into place, squared and shimmed to match the cartridge frame, and held in place with clamps at a depth that allows the OSB to be installed flush with the front of the cartridge.
5. 7/16 in (11 mm) OSB sheets are installed horizontally and offset by four feet using shims at the top and bottom plate to create gaps at each fastener. Sheathing is then affixed according to the recommendations made in the APA Engineered Wood Construction Guide.
6. Two electrical outlets and a switch are installed as per standard practice.
7. Backer rod and sealant are installed on the left, right, and top of the wall to complete the wall-to-cartridge air sealing.
8. Insulation is installed as per manufacturer's recommendations.
9. Interior gypsum wall board is installed on the interior surface using shims at the top and bottom plate to create gaps at each fastener.
10. Building wrap is installed over the exterior OSB as per the manufacturer's recommendations.
11. The vertical edges of the building wrap are taped to the cartridge.
12. 4 in (100 mm) vinyl siding is installed as per the Vinyl Siding Installation Manual.
13. The interior and exterior surface thermistor arrays are installed and tested.
14. The wall system is inspected and photographed.
15. The cartridge containing the wall is installed into the test box.
16. An air leakage test is performed before testing commences.

1.5 Test Procedure

Each of the tested reference walls was built with intentional air leakage paths across the assembly; 1/32” spacers were affixed to the top and bottom plates on both sides of the assembly to space-off both the exterior sheathing and the interior drywall. The exterior sheathing was installed as per APA installation requirements so 1/8” horizontal gap was maintained between the upper and lower sheets. The combination of the imposed gaps at the top and bottom plates and the horizontal gap in the sheathing provided a repeatable assembly indicative of standard construction practice. Each assembly was tested with these gaps and was labelled an “as-built” assembly. Table 3 contains the test points for each as-built assembly.

Table 3 - As-Built Testing

As-Built Wall Assembly - Constructed with Characteristic Air Leaks									
Test Segment	A	B	C	D	E	F	G	H	I
Meter Box °C (°F)	22 (72)								
Climate Box °C (°F)	62 (144)	42 (108)	2 (36)	-18 (0)	-28 (-18)	42 (108)	42 (108)	-18 (0)	-18 (0)
Air Transfer	None					Infiltration (10 Pa)	Exfiltration (10 Pa)	Infiltration (10 Pa)	Exfiltration (10 Pa)

Once the as-built testing was completed, the wall was removed from the testing apparatus and sealed on both sides using thin polyethylene sheeting and two-sided and one-sided tape. The wall was then re-installed, air leakage tested, and tested to the points shown in Table 4.

Table 4 - Sealed Testing

Sealed Assembly - Sealed as an Air Tight Assembly					
Test Segment	J	K	L	M	N
Meter Box °C (°F)	22 (72)				
Climate Box °C (°F)	62 (144)	42 (108)	2 (36)	-18 (0)	-28 (-18)
Air Transfer	None				

1.6 Energy Balance

General Energy Balance without Induced Airflow

For this protocol, all measurements of heat flow are made in the meter box, regardless of the operating mode. When no airflow is induced, the Thermal Metric hot box operates in a manner similar to other hot boxes. Heat is added to the box by the heating arrays and the circulation fans. Heat is removed from the box by the cooling coil. A small amount of heat flows into or out of the meter box walls depending on how well the guard loop eliminates the temperature difference across the walls of the box. When the climate box is simulating a heating climate, where the climate box is colder than the meter box, heat will flow out of the perimeter, flanking the guard. In hot box terminology this is referred to as a flanking loss. When the climate box is modeling a cooling climate, where the climate box is hotter than the meter box, heat will flow into the perimeter so that the flanking loss appears as a gain. Although there is no intentional pressure-induced airflow in this particular test, a small amount of air movement occurs due to stack effect within the wall specimen and the climate box fans drawing air at the top of the wall. To ensure this is captured, a CO₂ tracer gas system is used to measure the transfer of air between the meter box and the climate box. At each test point, a CO₂ gradient is created across the specimen and a mass flow equation based on the decay of CO₂ from the meter box into the climate box facilitates calculating the air transfer through the specimen.

General Energy Balance with Induced Airflow

When airflow is induced, two additional heat flows must be considered: heat moved with the air through the transfer fan and heat moved with the air infiltrating or exfiltrating through the test wall specimen. The transfer air heat flow is measured directly using the mass flow sensor and with the CO₂ decay. When the meter and climate boxes are connected with airtight seals against the cartridge, the system is closed and the airflow through the test wall specimen must be equal to the airflow measured by the mass flow sensor in the air transfer system (ATS). In theory, the heat moved by this airflow can be calculated using $m \cdot c \cdot \Delta T$; however, airflow through the test wall specimen changes the temperature field so that the apparent conductance of the specimen is changed. This is referred to as the "interaction" between airflow and heat flow. The TM research team is exploring ways to account for this interaction in new thermal metrics.

Calibration Panel and Flanking Loss Equations

Calibration of the Thermal Metric apparatus was completed in 2009. The following is a brief summary of this process. The calibration enabled the calculation of the flanking loss as a function of the climate box temperature. A black painted 4 in. thick EPS panel fitted to the cartridge was prepared from a single lot of EPS foam by gluing 4’x8’ sheets in an offset pattern. Samples for C518 testing were taken, glued and painted, from the same lot of foam. The samples were tested in a LaserComp Fox314 machine over the range of temperatures the walls were expected to experience during testing. The calculated predicted heat flow through the specimen was compared to the test data to develop the corrections or offsets required due to flanking losses and gains. The CO₂ system was employed to account for the limited, but important, air transfer through the sealed calibration panel. Figure 30 contains the graph developed from the calibration testing. A third-order polynomial was used to develop an R² fit of 0.9995. This equation indicates the heat flow due to flanking as a function of the climate box temperature and was used to correct the energy flows during the data analysis. Upon completion of the reference wall testing, a two-point verification of the calibration was completed and showed that the calibration remained accurate to within 2.4% over 20 months of continuous testing.

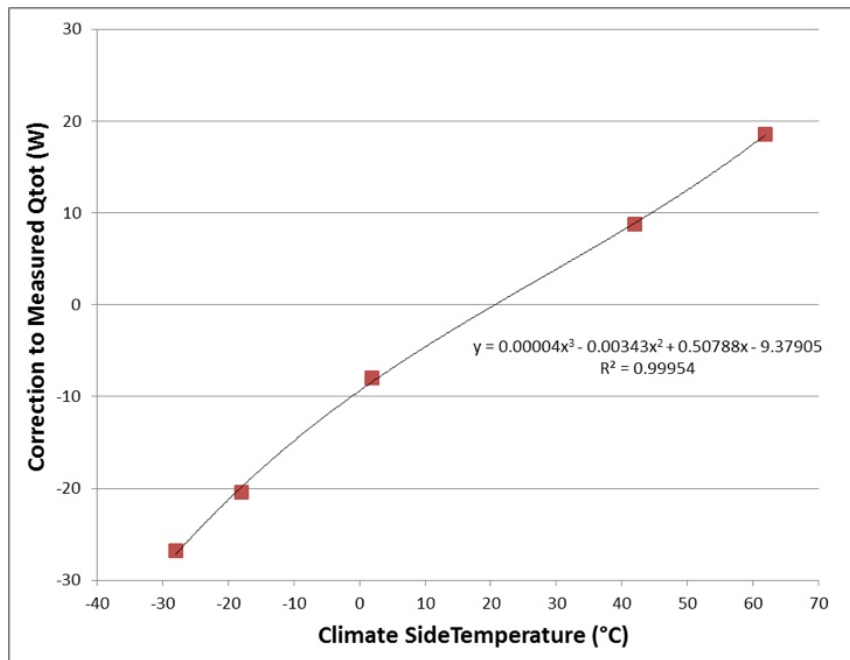

Figure 30 – Original Flanking Correction

Further calibration measurements were made on the same 4 in. thick high density (HD) EPS calibration panel and on a built-up calibration panel comprising the 4 in. thick HD EPS calibration panel and a 2.5 in. HD EPS calibration panel. The body of calibration data was used to tune THERM models of the critical cross sections of the hot box apparatus and the calibration panels. Using this approach we were able to improve on the original calibrations and develop an array of calibration factors that covers a range of panel thicknesses, climate-side surface heat transfer coefficients, climate box temperatures and air-to-air temperature differences. The improved calibration factors are presented in Table 5.

2015-06-18 – Thermal Metric Summary Report (June 2015 Update)

Table 5 – Improved calibration factors to cover full range of Reference Walls tested

Wall Thickness (in.) (mm)		hin hout (w/m2) (w/m2)		Correction Factors in (W) and (W/K) for given Climate Box Temperatures (°C)									
				62 42 2 -18 -28					62 42 2 -18 -28				
				Absolute Correction (W)					Correction as fn of Air-Air deltaT (W/K)				
4	101.6	7	7	11.27	5.36	-5.67	-17.21	-23.78	0.2816	0.2681	0.2835	0.4301	0.4756
			14	11.42	5.43	-5.79	-17.57	-24.43	0.2855	0.2717	0.2894	0.4393	0.4886
			28	11.45	5.48	-5.79	-17.78	-24.64	0.2863	0.2740	0.2896	0.4444	0.4928
4.5	114.3	7	7	10.09	4.85	-5.05	-14.95	-20.62	0.2523	0.2425	0.2527	0.3737	0.4124
			14	10.23	4.91	-5.16	-15.32	-21.06	0.2558	0.2456	0.2578	0.3829	0.4213
			28	10.29	4.94	-5.19	-15.47	-21.30	0.2573	0.2471	0.2596	0.3869	0.4261
5	127	7	7	9.21	4.36	-4.89	-13.21	-17.78	0.2303	0.2179	0.2444	0.3303	0.3556
			14	9.24	4.41	-4.96	-13.46	-18.22	0.2310	0.2204	0.2478	0.3364	0.3645
			28	9.38	4.48	-5.00	-13.66	-18.41	0.2344	0.2238	0.2502	0.3416	0.3682
6.5	165.1	7	7	6.77	3.21	-3.43	-9.82	-13.97	0.1693	0.1603	0.1717	0.2454	0.2795
			14	6.84	3.24	-3.47	-9.97	-14.21	0.1711	0.1620	0.1737	0.2494	0.2841
			28	6.87	3.26	-3.49	-10.13	-14.35	0.1718	0.1628	0.1747	0.2533	0.2869

1.1 Energy and Airflow

To understand the heat flows associated with airflow, the two imposed airflow cases of infiltration and exfiltration must be understood and quantified.

The infiltration (drawing air from the meter box) and exfiltration (supplying air to the meter box) tests were completed by imposing a 10Pa pressure differential over the wall specimen. Because each wall is different, the amount of air required to create a 10Pa differential varies. Wall 2 (Inset FG 2x4), Wall 3 (Face FG 2x4), and Wall 4 (Cellulose 2x4) have very similar constructions with the only difference being inset versus face-stapled batts versus damp sprayed cellulose. Figure 31 shows the air transfer rates in cubic feet per minute calculated on a mass basis from CO₂ decay. The figure shows that, under normal operating conditions, Wall 3 (face-stapled R13 FG batt) is slightly more resistant to airflow than Wall 2 (inset-stapled R13 FG batt). Wall 4 (damp-sprayed CFI) is more resistant to airflow than Walls 2 and 3. This order of airflow resistance is also visible under imposed 10Pa conditions at almost all temperatures. Note that the air leakage rates are higher at colder temperatures.

Figure 32 shows the information in Figure 31 divided by the area of the wall to show the leakage per square foot of wall surface. Figure 33 shows the energy flow in watts correlating to the information in Figure 31 for Wall 2, Wall 3, and Wall 4. These figures also show that very minimal airflow and heat flow were measured in the sealed wall tests.

2015-06-18 – Thermal Metric Summary Report (June 2015 Update)

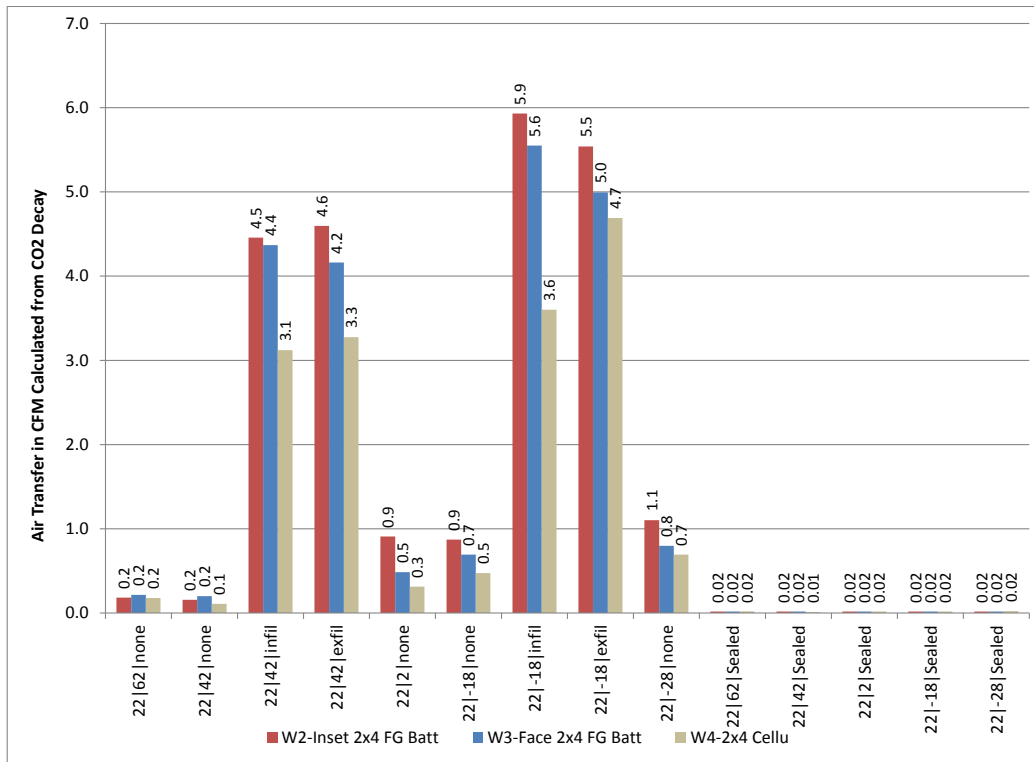

Figure 31 – Wall 2, Wall 3, and Wall 4 Air Transfer Rates in CFM

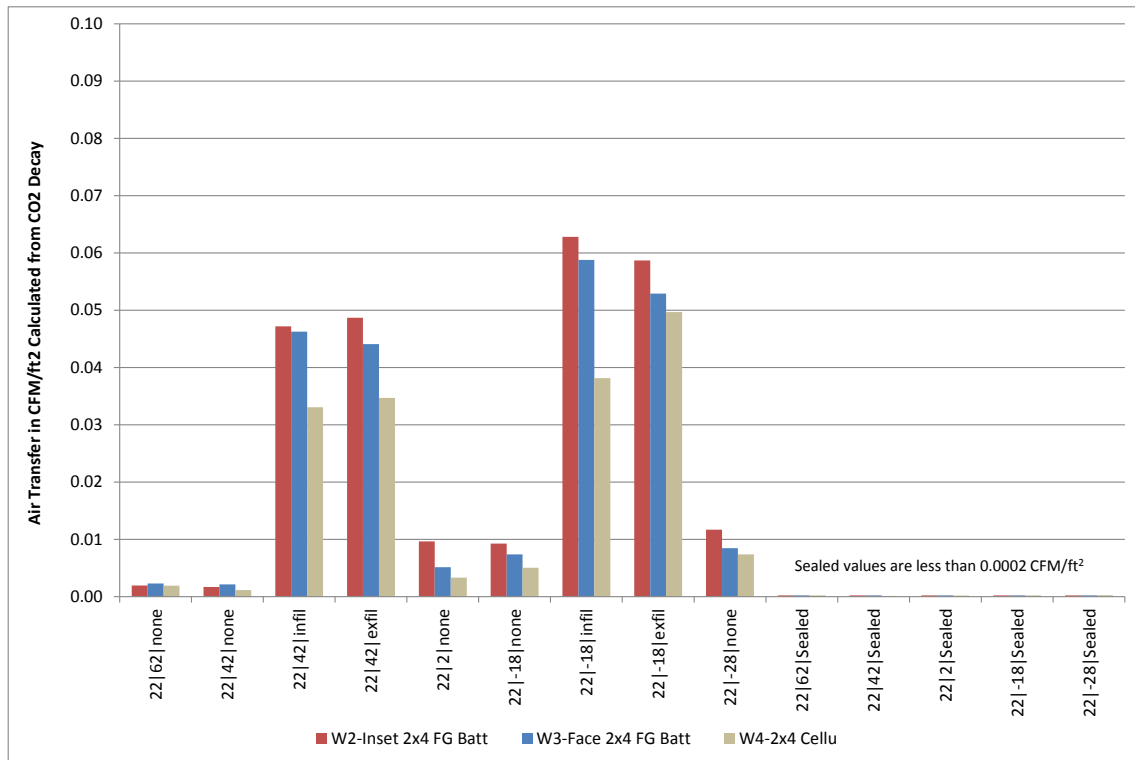

Figure 32 – Wall 2, Wall 3, and Wall 4 Air Transfer Rates in CFM/ft²

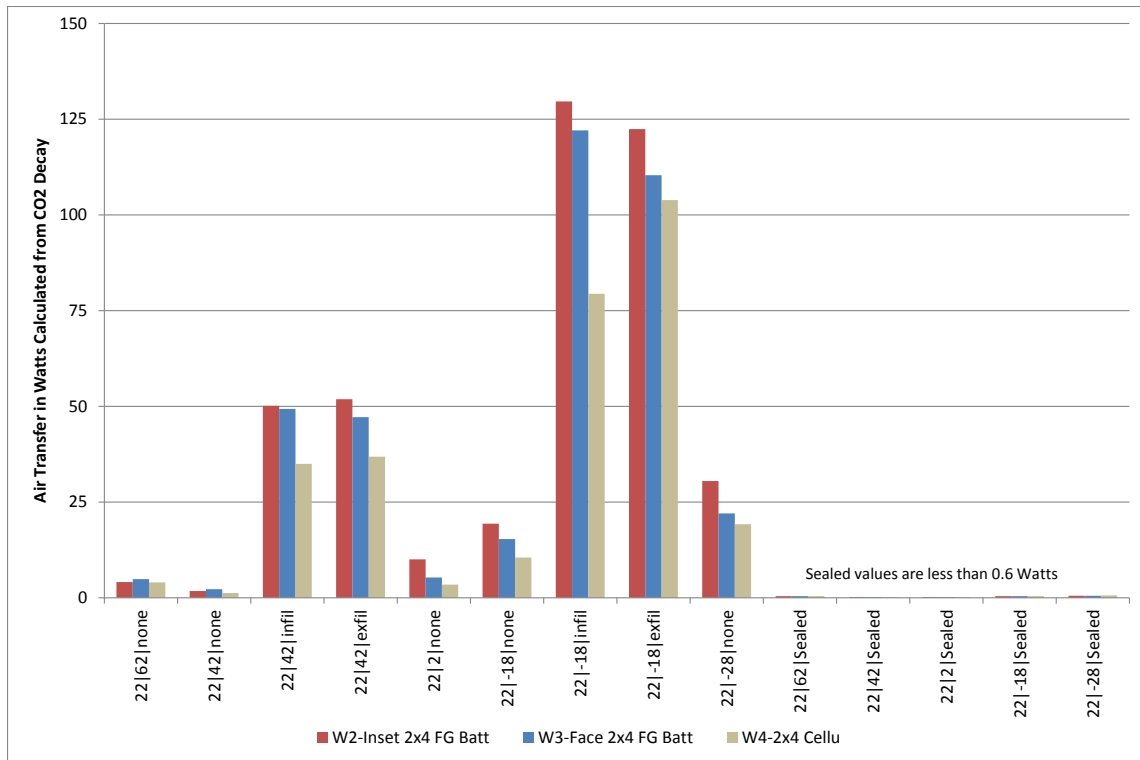

Figure 33 – Wall 2, Wall 3, and Wall 4 Air Transfer Rates in Watts

Wall 5 and Wall 6 have very similar constructions with the only difference being the type of spray polyurethane foam. Wall 5 is open-cell spray foam installed to overfill the stud bay and then scarfed back to the 2x4 studs. Wall 6 is approximately 2 in. of closed-cell spray foam; the depth of ccSPF was intended to result in roughly the same R-value as the other 2x4 test walls (nominally R13). Wall 2 was included in the following graphs for comparison purposes. Walls 5 and 6 (spray foam) exhibited lower air leakage rates than Wall 2 (inset-stapled fiber glass batt). Wall 5 (open-cell) exhibits less air leakage than Wall 6 (closed-cell) at lower temperatures but more air leakage at higher temperatures.

Figure 34 shows the air transfer rates in cubic feet per minute calculated on a mass basis from CO₂ decay. Figure 35 shows the information in Figure 34 divided by the area of the wall to show the leakage per square foot of wall surface. Figure 36 shows the energy flow in watts correlating to the information in Figure 34 for Wall 2, Wall 5, and Wall 6. These figures also show that very minimal airflow and heat flow were measured in the sealed wall tests.

The test results show the inherent air sealing benefits of spray foam insulations. However, spray foam insulations only seal areas where the spray foam is installed; significant leakage paths often remain at wood-to-wood connections. The Thermal Metric tests consider only a clear wall section, but most air leakage in real buildings occurs through large openings and long cracks, for example at the interface between the wall framing and a window, door or mechanical penetration or through joints between bottom plates and floor sheathing, floor sheathing and rim joists, rim joists and top plates, etc. None of these connections were considered in the current TM scope of research.

2015-06-18 – Thermal Metric Summary Report (June 2015 Update)

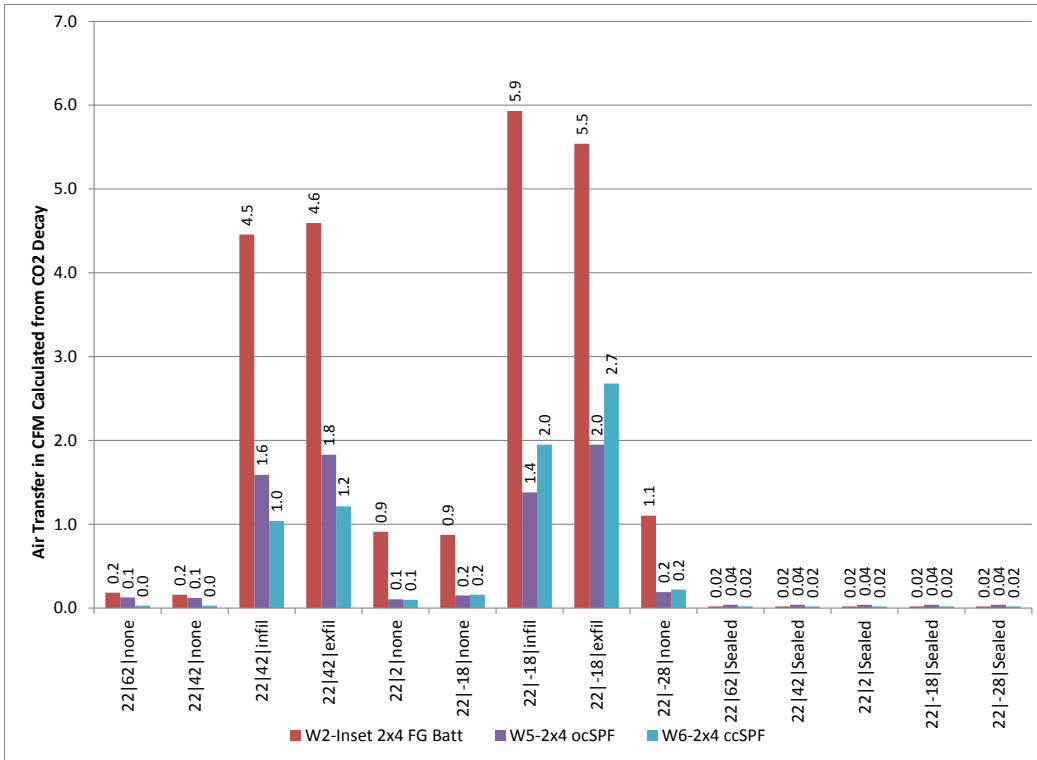

Figure 34 – Wall 2, Wall 5, and Wall 6 Air Transfer Rates in CFM

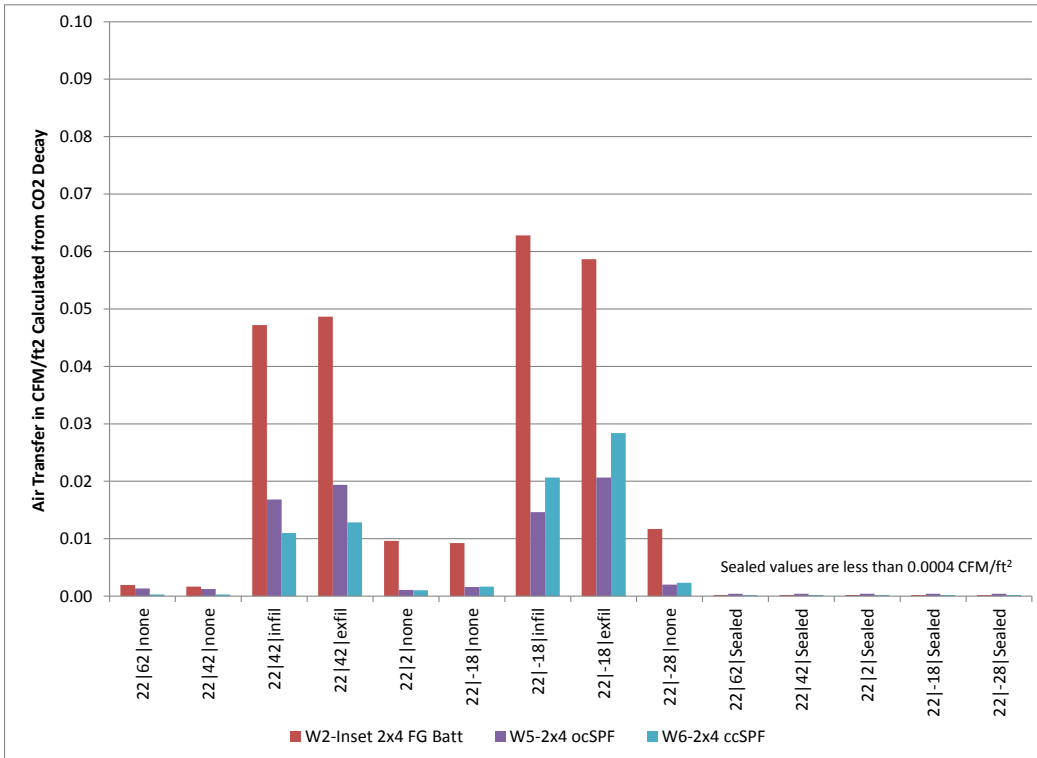

Figure 35 – Wall 2, Wall 5, and Wall 6 Air Transfer Rates in CFM/ft²

2015-06-18 – Thermal Metric Summary Report (June 2015 Update)

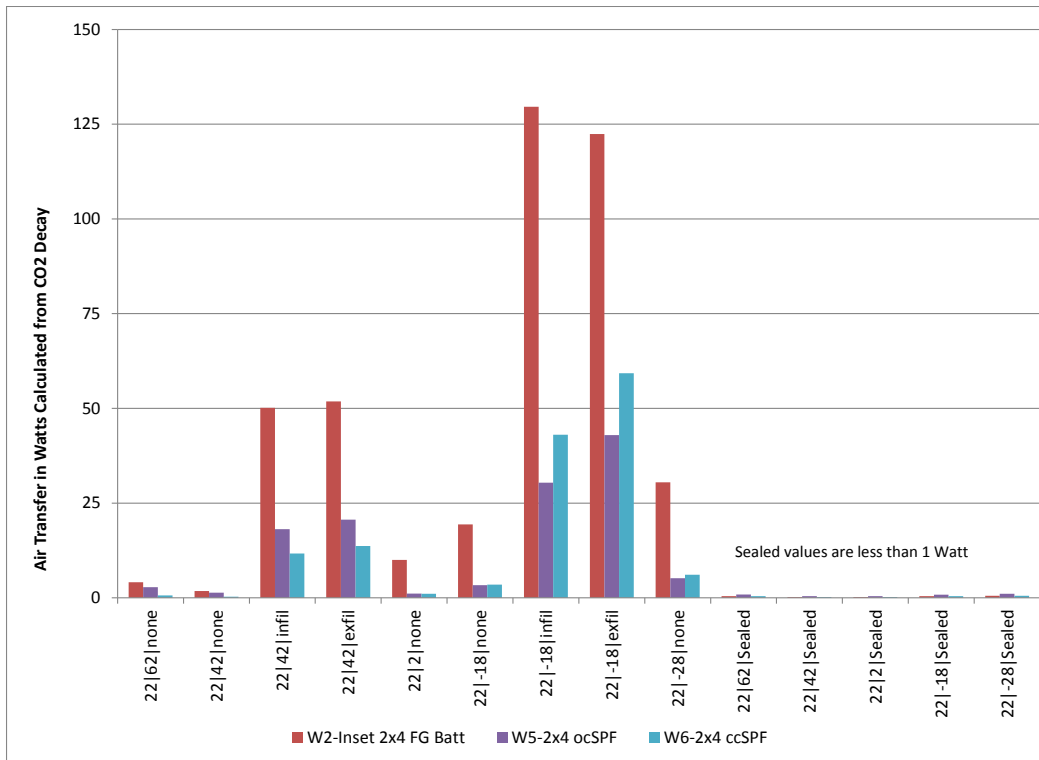

Figure 36 – Wall 2, Wall 5, and Wall 6 Air Transfer Rates in Watts

Notation and Abbreviations

The abbreviations summarized in Table 6 are used extensively in the data analysis sections that follow. Q_{tot} (meas) is the measured energy input into the meter box to maintain 22°C. The Q_{tas} is a mass flow calculation based on the temperature of the air entering the meter box during a forced exfiltration case. Q_{twa} is a temperature-corrected heat flow measured by the mass flow sensors within the air transfer system. Q_{mcdT} is calculated from the CO₂ mass decay between the meter box and climate box. Q_{mcdT} is used to correct for the airflow through the specimen.

Table 6 - Abbreviations for Data Analysis

Abbreviation	Description
Q _{tot} (meas)	Heating & Cooling provided to Meter Box Measured sum of heaters, cooling coil and circulation fans
Q _{correction}	Flanking correction Determined from calibration panels and heat flow analyses 3 rd order polynomial based on Climate Box temperature
Q _{tas}	Heat flow associated with Air Transfer System Calculated from ATS Mass Flow MB Inlet Temperature MB Air Temperature Used to calculate heat added to Meter Box by airflow during exfiltration tests (controls minimize this so the value approaches 0)
Q _{twa}	Heat flow associated with airflow through wall assembly (induced) Calculated from ATS Mass Flow MB Air Temperature CB Air Temperature
Q _{mcdT}	Heat flow associated with airflow through wall assembly (non-induced) Calculated from CO ₂ Tracer Gas Air Exchange MB Air Temperature CB Air Temperature

1.2 Example Energy Balance

Using Wall 2 as an example, the following diagrams indicate where each of the heat flow measurements were taken and their value at each set point throughout the testing. On the right-hand side of each graphic is the calculation method to determine the final energy flow, which is used to calculate the apparent R-value of the assembly at each test point. Tabular summarized data for the Wall 2 graphic analysis can be found in the wall summaries of Section 3 along with the breakdown analyses for the other test wall specimens.

The following equations are used at each test point:

Set Points – 62°C, 42°C, 2°C, -18°C, -28°C, -18°C Infiltration, 42°C Infiltration

$$Q_{tot} (meas) + Q_{corr} = Q (final)$$

Set Points – -18°C Exfiltration, 42°C Exfiltration

$$Q_{tot} (meas) + Q_{corr} + Q_{tas} = Q (final)$$

$Q (final)$ is then used to calculate the reported apparent R-value using the wall surface area and the surface to surface differential temperature measured at each test point. This information is also shown in the summary tables.

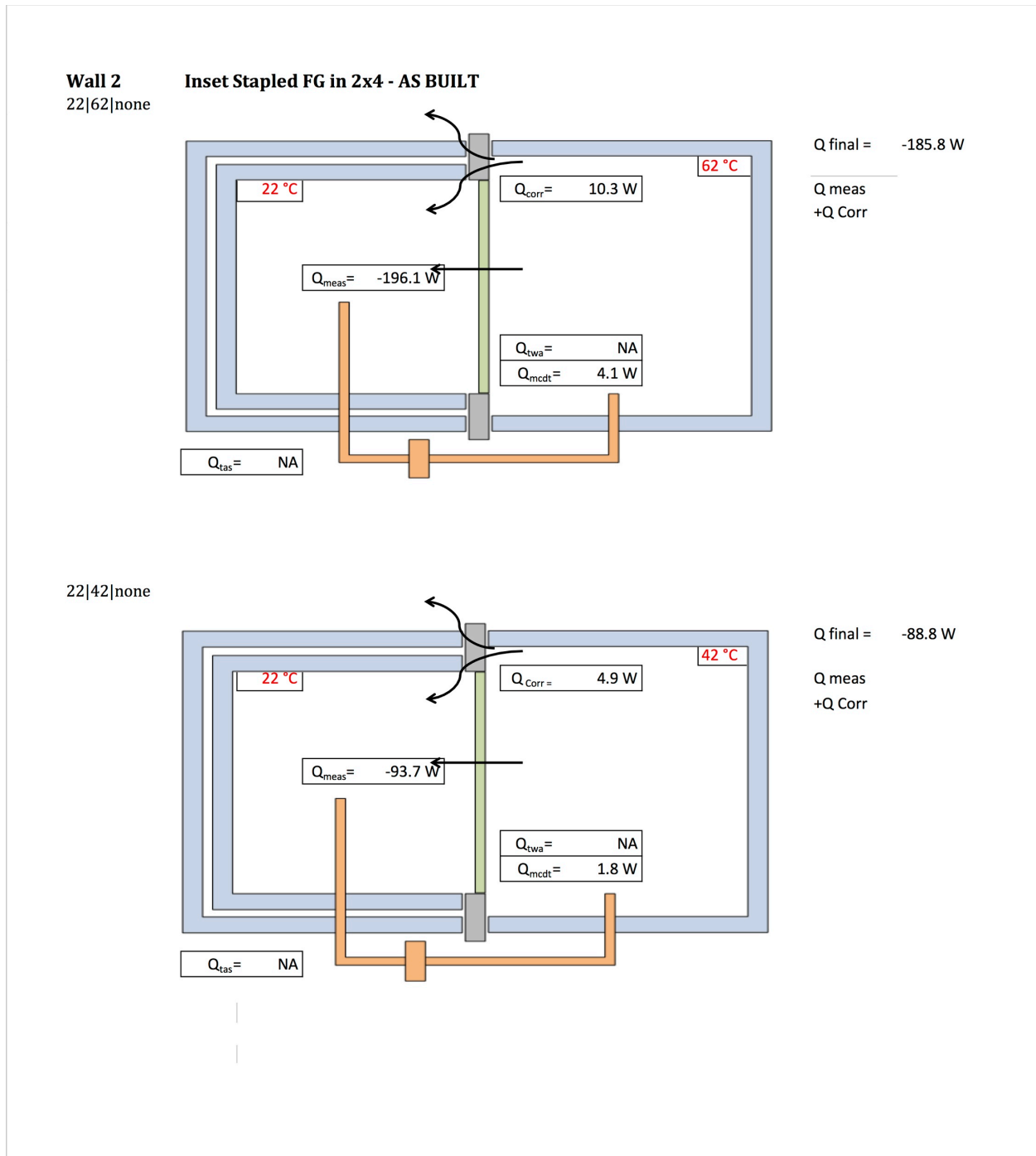

Figure 37 – Wall 2 As-Built 62°C and 42°C Data

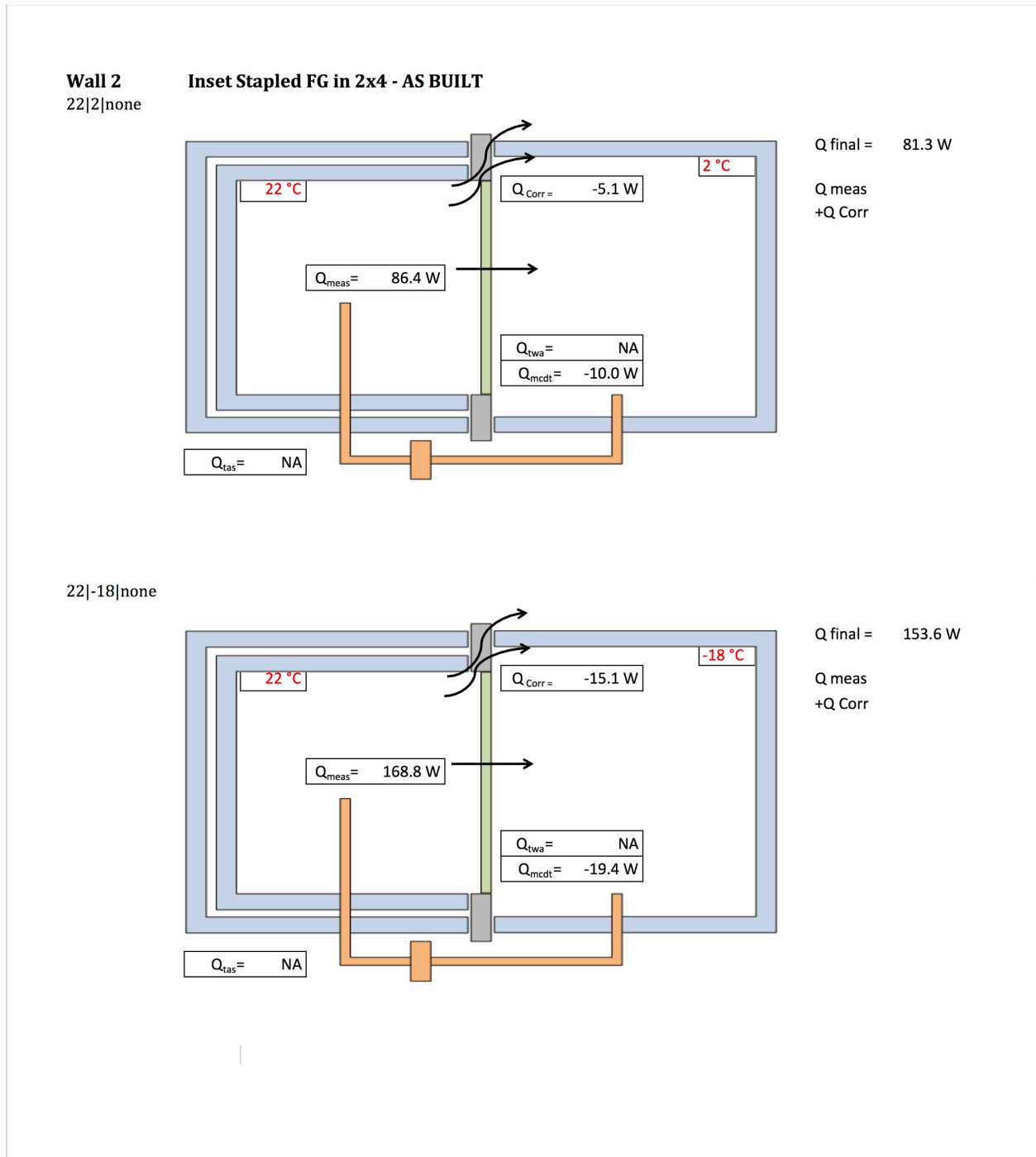

Figure 38 – Wall 2 As-Built 2°C and -18°C Data

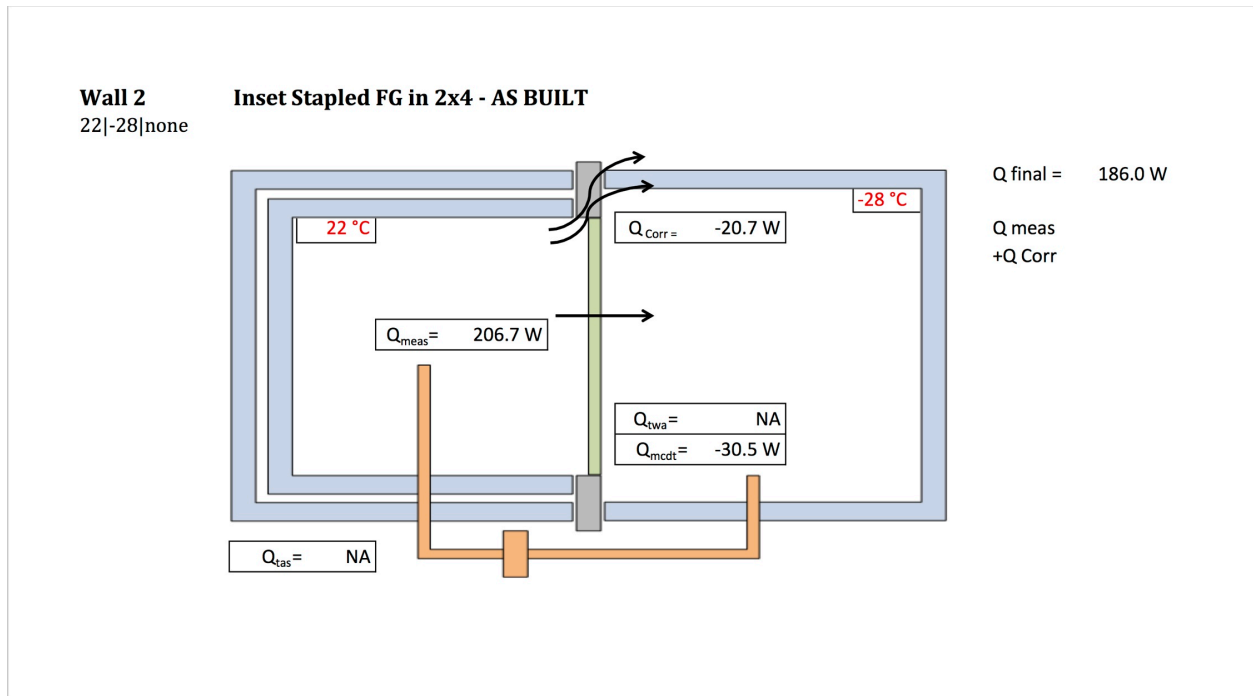

Figure 39 – Wall 2 As-Built -28°C Data

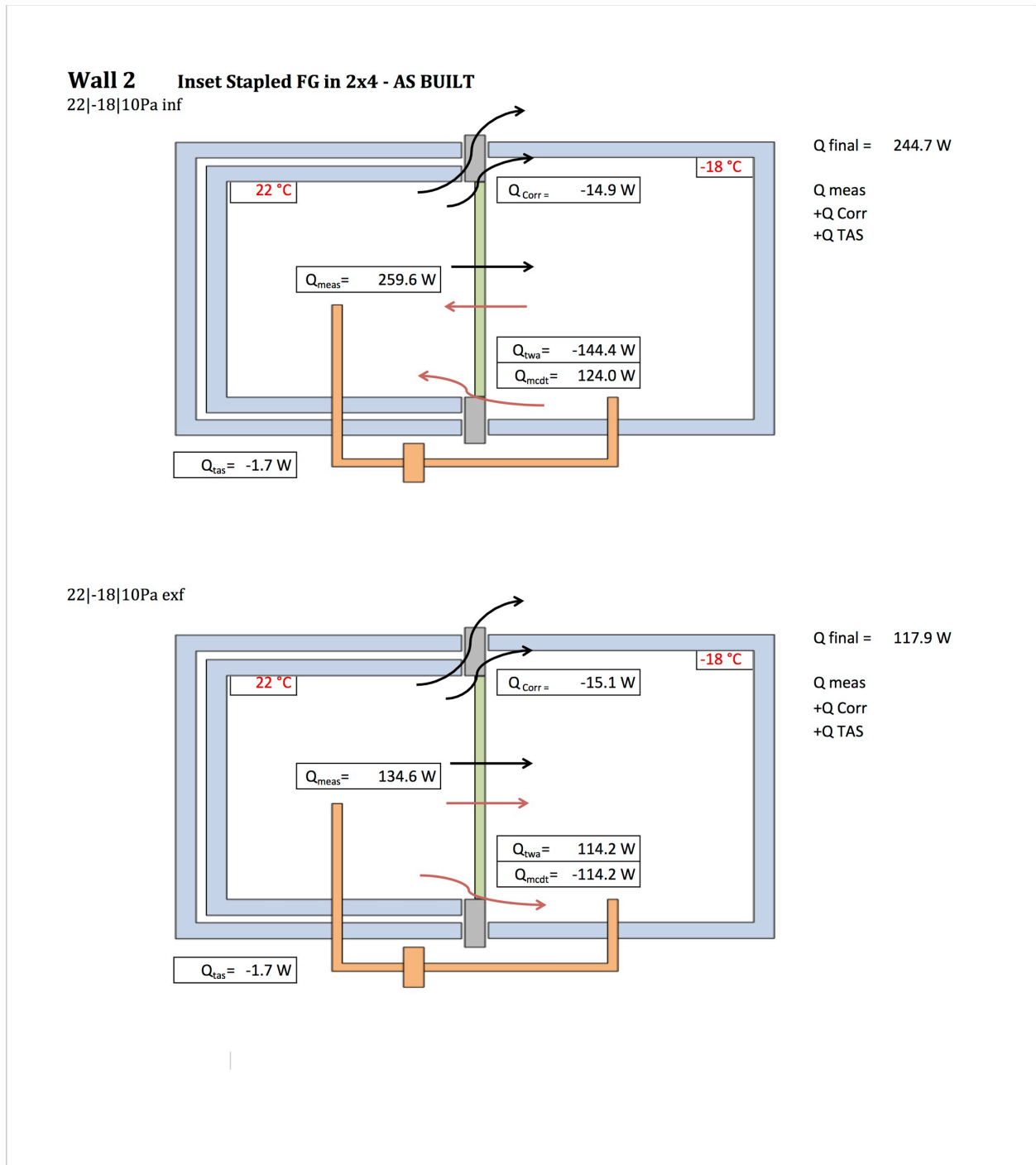

Figure 40 – Wall 2 As-Built -18°C Infiltration/Exfiltration Data

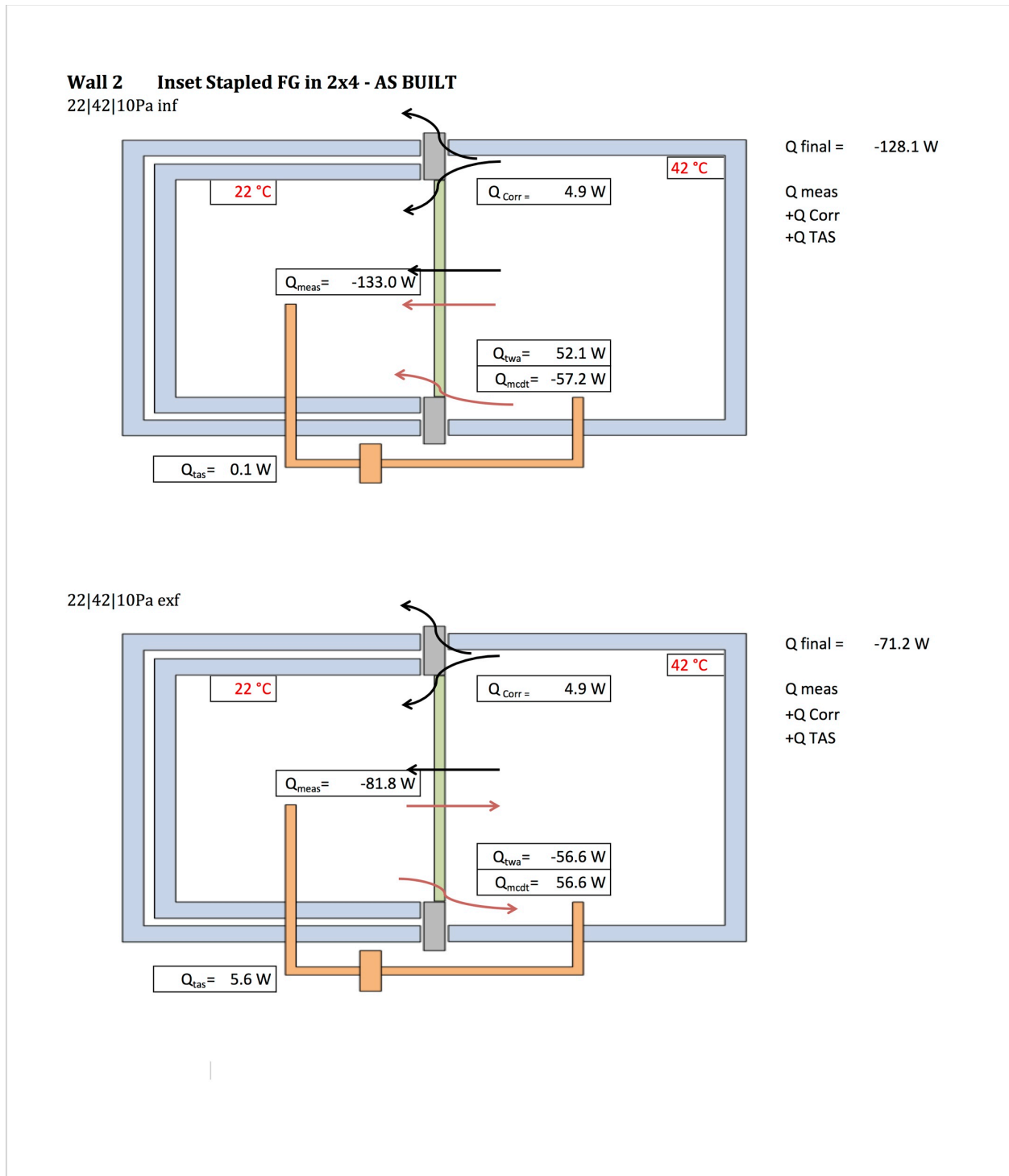

Figure 41 – Wall 2 As-Built 42°C Infiltration/Exfiltration Data

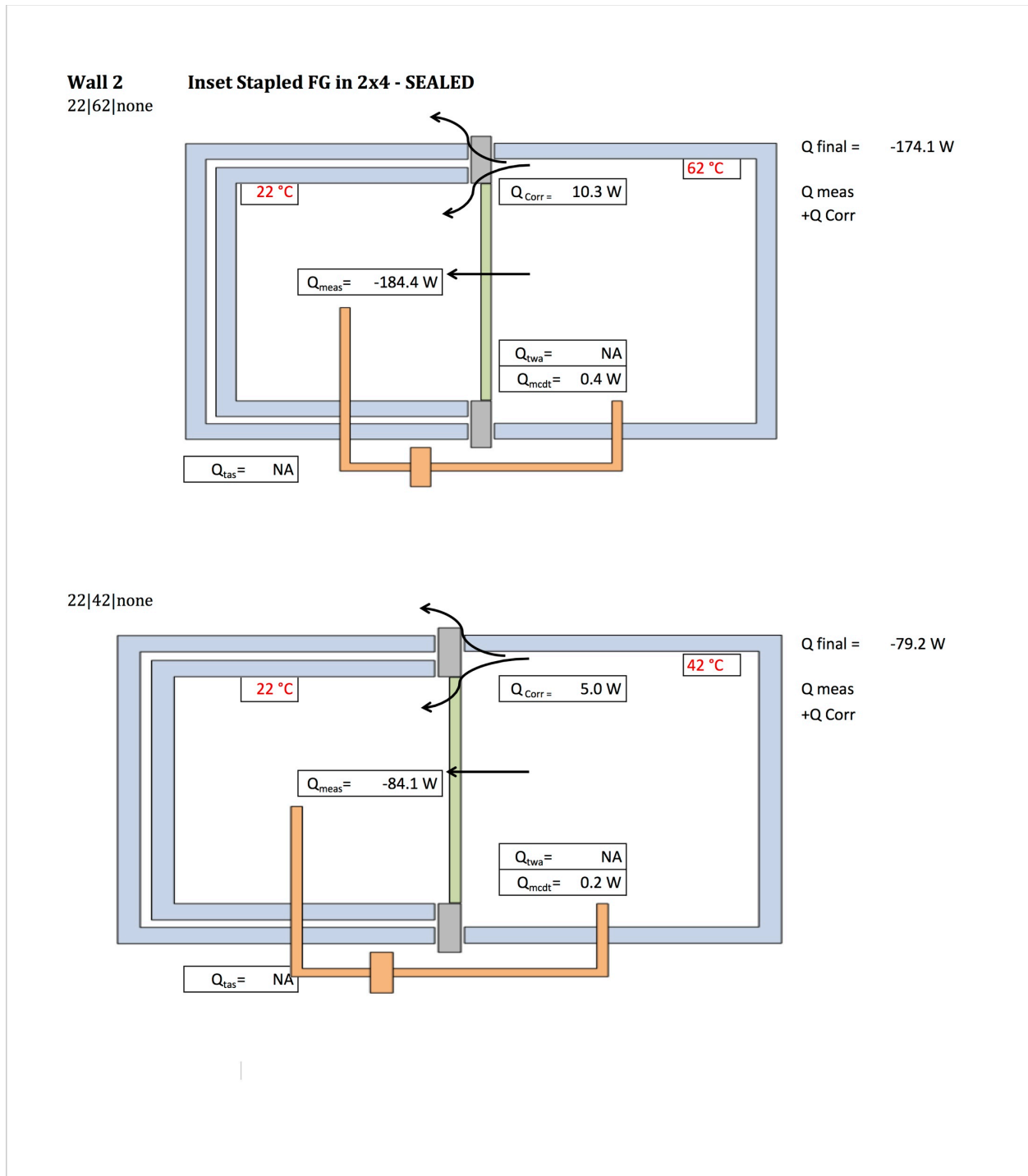

Figure 42 – Wall 2 Sealed 62°C and 42°C Data

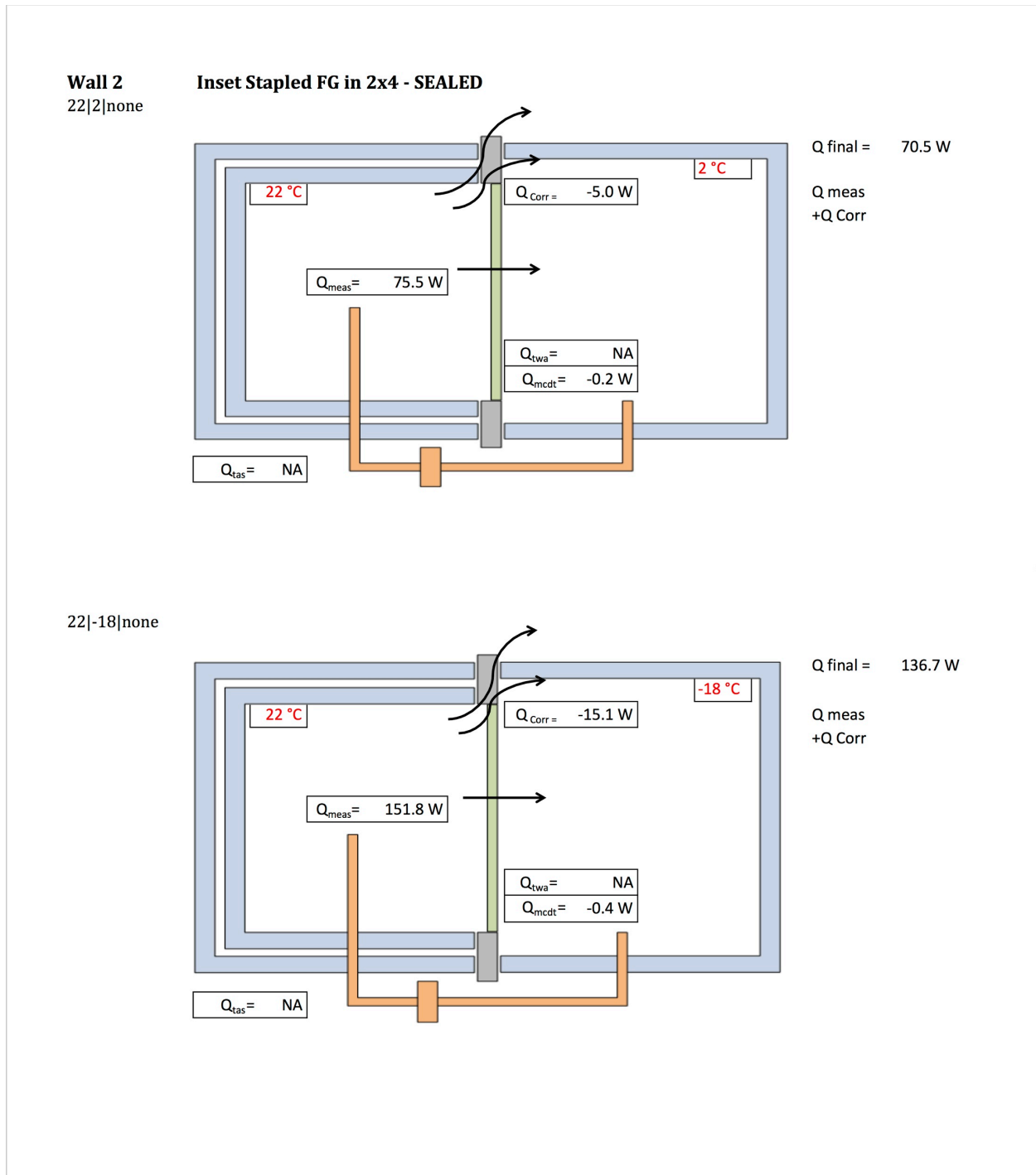

Figure 43 – Wall 2 Sealed 2°C and -18°C Data

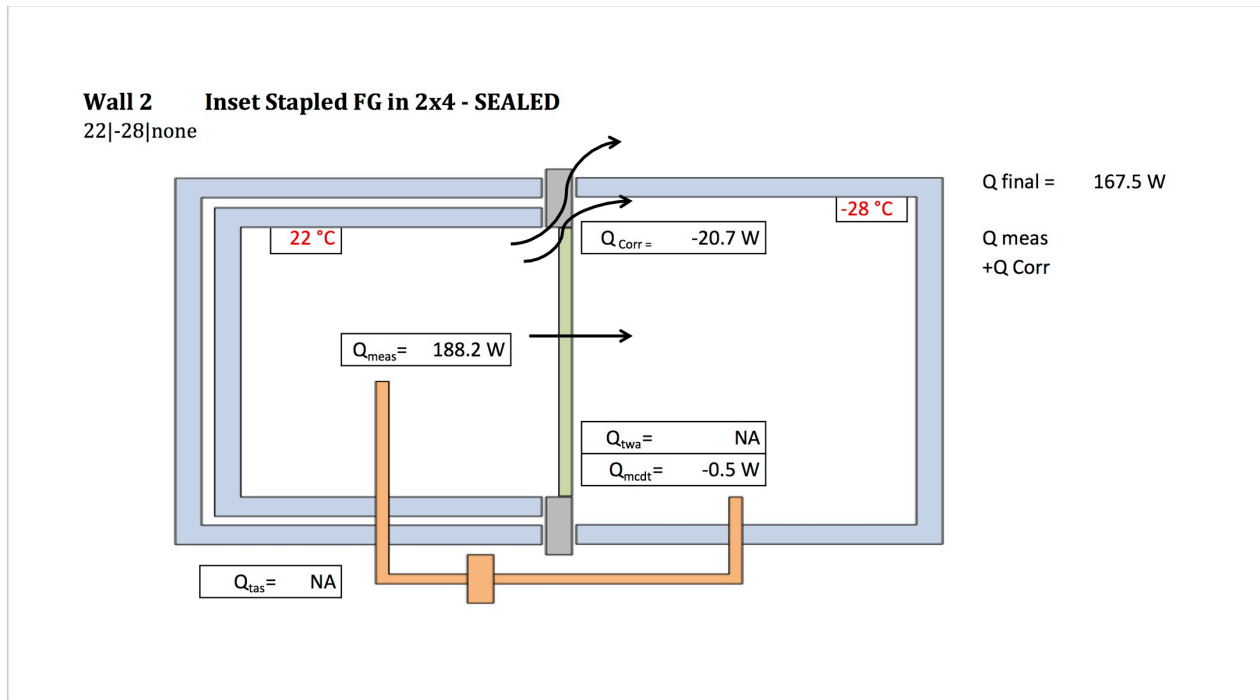

Figure 44 – Wall 2 Sealed -28°C Data

2 Approach to Data Analysis of Reference Walls

The construction industry has used a number of different concepts and metrics to quantify, discuss, and compare the thermal performance of wall assemblies. Several of these are considered in this section of the report in relation to the Thermal Metric reference walls. Advantages and limitations are addressed and further refinements are suggested. Finally, this section of the report summarizes the approach taken to analyzing the reference wall data presented in section 3.

2.1 Installed R-Value

Installed R-value is the most basic of the thermal metrics that are commonly used to compare the thermal performance of wall assemblies. Only the R-value of the *installed insulation* is considered; the modest but non-zero thermal resistance of other layers, for example, gypsum wall board, OSB, air spaces, surface films, etc., is excluded.

Table 5 summarizes the installed R-value for Walls 2 through 8 of the Thermal Metric Reference Wall series. Walls 2 through 7 employed 2 x 4 wood stud frames while Wall 8 employed a 2x6 wood stud frame.

Table 7 – Installed R-Values for TM Reference Walls

Wall Label	Installed Insulation	Installed R-Value
W2 - Inset R13 FG	R13 Inset-stapled kraft fiber glass batt	13
W3 - Face R13 FG	R13 Face-stapled kraft fiber glass batt	13
W4 - dsCFI	3.5 in. damp-sprayed cellulose	13 ¹
W5 - ocSPF	3.5 in. (nominal) oc SPF (0.5 pcf)	12.6 ²
W6 - ccSPF	2 in. (nominal) cc SPF (2.0 pcf)	12 ³
W7 - R13 FG + R5 XPS	R13 unfaced fiber glass batt + R5 XPS (continuous exterior insulation)	13 + 5 = 18
W8 - R21 FG (2x6)	R21 unfaced fiber glass batt	21

- 1) <http://energy.gov/energysaver/articles/insulation-materials> - cellulose fiber insulation: 3.6 to 3.8, avg. of R 3.7 / in.
- 2) <http://energy.gov/energysaver/articles/insulation-materials> - open-cell spray polyurethane foam: R 3.6 / in.
- 3) <http://energy.gov/energysaver/articles/insulation-materials> - closed-cell spray polyurethane foam: 5.5 to 6.5, avg. of R 6.0 / in.

The biggest advantage of installed R-Value is that it provides a very convenient metric. Installed R-values are relatively easy to determine: one simply has to add up the labelled R-values on the installed insulation products.

Installed R-Value is limited in that it does not account for the thermal resistance of non-insulation layers or the thermal bridging associated with penetrating structural elements, fasteners, etc.

2.2 Center-of-Cavity R-value

Center-of-cavity R-value is another commonly used thermal metric for wall assemblies. This metric improves upon installed R-value by accounting for more of the materials that make up the wall assembly. The center-of-cavity R-value is determined by adding up the thermal resistance of each layer along the cross section that includes the most insulation (typically a line through the center of the stud space).

Table 8 summarizes the installed R-value for Walls 2 through 8 of the Thermal Metric Reference Wall series.

Table 8 – Center-of-Wall R-Values for TM Reference Walls

Wall Label	Ext. Air Film ¹	Vinyl Siding ²	Ext. Insul.	OSB ³	Cavity Insul.	GWB ⁴	Int. Air Film ⁵	Center-of-Cavity R-Value
W2 - Inset R13 FG	0.17	0.62	NA	0.88	13	0.45	0.62	15.7
W3 - Face R13 FG	0.17	0.62	NA	0.88	13	0.45	0.62	15.7
W4 - dsCFI	0.17	0.62	NA	0.88	13	0.45	0.62	15.7
W5 - ocSPF	0.17	0.62	NA	0.88	12.6	0.45	0.62	15.3
W6 – ccSPF	0.17	0.62	NA	0.88	12	0.45	0.62	14.7
W7 - R13 FG + R5 XPS	0.17	0.62	5	NA	13	0.45	0.62	19.9
W8 - R21 FG (2x6)	0.17	0.62	NA	0.88	21	0.45	0.62	23.7

- 1) ASHRAE Handbook of Fundamentals 2009 SI - Exterior Air Film - RSI 0.030, R 0.17
- 2) ASHRAE Handbook of Fundamentals 2009 SI - Vinyl Siding, hollow-backed over shthg - RSI 0.11, R 0.62
- 3) ASHRAE Handbook of Fundamentals 2009 SI - Oriented Strand Board (OSB) - k=0.072 w/m·K, t=11.1 mm, R 0.88
- 4) ASHRAE Handbook of Fundamentals 2009 SI - Gypsum Wall Board (GWB) - k=0.16 w/m·K, t=12.7 mm, R 0.45
- 5) ASHRAE Handbook of Fundamentals 2009 SI - Interior Air Film - RSI 0.11, R 0.62

Center-of-Wall R-Value is relatively easy to calculate: one simply has to add up the R-values of each layer in the assembly. However, Center-of-Wall R-value is a limited metric in that it does not account for the thermal bridging associated with penetrating structural elements, fasteners, etc.

2.3 Clear-Wall R-value

The third commonly used thermal metric, Clear-Wall R-value, does account for the thermal bridging associated with necessary and repetitive structural elements (e.g. studs, strapping, furring, girts, etc.) The Clear-Wall R-value considers the heat flow through a clear section of wall with no fenestrations, corners, or connections between other envelope elements such as roofs, foundations, and other walls.

Table 9 and Table 10 present the Clear-Wall R-values for the TM Reference Walls, assuming framing R-values of R1.0 /in. and R1.9 / in. respectively.

Table 9 – Clear-Wall R-Values for TM Reference Walls (Assuming R1.0 / in. for S-P-F framing)

Wall Label	Center-of-Cavity R-Value	Path	Material	Layer R-Value	Path R-Value	% Area ⁶	Clear-Wall U-value ⁷	Clear-Wall R-Value
W2 - Inset R13 FG	15.7	Center-of-Cavity	R13 FG batt	13	15.7	86.3	0.077	13.0
		Stud	3.5 in. S-P-F	3.5 ¹²³	6.2 ⁵	13.7		
W3 - Face R13 FG	15.7	Center-of-Cavity	R13 FG batt	13	15.7	86.3	0.077	13.0
		Stud	3.5 in. S-P-F	3.5 ¹²³	6.2 ⁵	13.7		
W4 - dsCFI	15.7	Center-of-Cavity	dsCFI	13	15.7	86.3	0.077	13.0
		Stud	3.5 in. S-P-F	3.5 ¹²³	6.2 ⁵	13.7		
W5 - ocSPF	15.2	Center-of-Cavity	0.5 pcf ocSPF	12.6	15.2	86.3	0.079	12.8
		Stud	3.5 in. S-P-F	3.5 ¹²³	6.2 ⁵	13.7		
W6 – ccSPF	14.7	Center-of-Cavity	2 in. ccSPF + 1.5 in. Airspace	12	14.7	86.3	0.078	12.9
		Stud	3.5 in. S-P-F	4.4 ¹²³	7.2 ⁵	13.7		
W7 - R13 FG + R5 XPS	19.9	Center-of-Cavity	R13 FG batt	13	19.9	86.3	0.057	17.6
		Stud	3.5 in. S-P-F	3.5 ¹²³⁴	10.4 ⁵	13.7		
W8 - R21 FG (2x6)	23.7	Center-of-Cavity	R21 FG batt	21	23.7	86.3	0.053	18.9
		Stud	5.5 in. S-P-F	5.5 ¹²³	8.2 ⁵	13.7		

- 1) Wilkes (1979): $k = 0.02582 + ((0.1686 + 0.005177 * M) * \rho) / (1000 * (1 + 0.01 * M))$, where k is conductivity (W/m-K), M = moisture content (%wt), rho = density (kg/m3)
- 2) S-P-F species group includes White Spruce (avg. S.G. = 0.36), Eastern White Pine (avg. S.G. = 0.37), Jack Pine (avg. S.G. = 0.45), Balsam Fir (avg. S.G. = 0.35)
- 3) For the Thermal Metric research project measured framing lumber density ranged from 300 to 550 kg/m3 (S.G. = 0.30 to 0.55); using Wilkes' equation framing lumber k might range from 0.076 W/m-K (R1.9 / in.) for 300 kg/m3 and 0% MC to 0.150 W/m-K (R1.0 / in.) for 550 kg/m3 and 20% MC; R1.0 / in. is assumed for this table (i.e. high end of conductivity for framing)
- 4) Includes 40 mm (1.5 in.) airspace at RSI 0.16 (R0.91), ASHRAE Handbook of Fundamentals 2009 SI
- 5) Path R-value through framing = Path R-value through insulation - Insulation Layer R-value + Framing Layer R-value
- 6) For the Thermal Metric research project Framing Factor = % Area of Framing = 13.7%; % Area of Insulation = 100 - % Area of Framing
- 7) Clear-Wall U-Value = (% Area Insulation / 100) / (Path R-Value through Insulation) + (% Area Framing / 100) / (Path R-Value through Framing)

2015-06-18 – Thermal Metric Summary Report (June 2015 Update)

Table 10 – Clear-Wall R-Values for TM Reference Walls (Assuming R1.9 / in. for S-P-F framing)

Wall Label	Center-of-Cavity R-Value	Path	Material	Layer R-Value	Path R-Value	% Area ⁶	Clear-Wall U-value ⁷	Clear-Wall R-Value
W2 - Inset R13 FG	15.7	Center-of-Cavity	R13 FG batt	13	15.7	86.3	0.069	14.4
		Stud	3.5 in. S-P-F	6.7 ¹²³	9.4 ⁵	13.7		
W3 - Face R13 FG	15.7	Center-of-Cavity	R13 FG batt	13	15.7	86.3	0.069	14.4
		Stud	3.5 in. S-P-F	6.7 ¹²³	9.4 ⁵	13.7		
W4 - dsCFI	15.7	Center-of-Cavity	dsCFI	13	15.7	86.3	0.069	14.4
		Stud	3.5 in. S-P-F	6.7 ¹²³	9.4 ⁵	13.7		
W5 - ocSPF	15.2	Center-of-Cavity	0.5 pcf ocSPF	12.6	15.2	86.3	0.071	14.1
		Stud	3.5 in. S-P-F	6.7 ¹²³	9.4 ⁵	13.7		
W6 – ccSPF	14.7	Center-of-Cavity	2 in. ccSPF + 1.5 in. Airspace	12	14.7	86.3	0.073	13.7
		Stud	3.5 in. S-P-F	6.7 ¹²³	9.4 ⁵	13.7		
W7 - R13 FG + R5 XPS	19.9	Center-of-Cavity	R13 FG batt	13	19.9	86.3	0.054	18.7
		Stud	3.5 in. S-P-F	6.7 ¹²³⁴	13.5 ⁵	13.7		
W8 - R21 FG (2x6)	23.7	Center-of-Cavity	R21 FG batt	21	23.7	86.3	0.047	21.4
		Stud	5.5 in. S-P-F	10.5 ¹²³	13.2 ⁵	13.7		

- 1) Wilkes (1979): $k = 0.02582 + ((0.1686 + 0.005177 * M) * \rho) / (1000 * (1 + 0.01 * M))$, where k is conductivity (W/m-K), M = moisture content (%wt), ρ = density (kg/m³)
- 2) S-P-F species group includes White Spruce (avg. S.G. = 0.36), Eastern White Pine (avg. S.G. = 0.37), Jack Pine (avg. S.G. = 0.45), Balsam Fir (avg. S.G. = 0.35)
- 3) For the Thermal Metric research project measured framing lumber density ranged from 300 to 550 kg/m³ (S.G. = 0.30 to 0.55); using Wilkes' equation framing lumber k might range from 0.076 W/m-K (R1.9 / in.) for 300 kg/m³ and 0% MC to 0.150 W/m-K (R1.0 / in.) for 550 kg/m³ and 20% MC; R1.9 / in. is assumed for this table (i.e. low end of conductivity for framing)
- 4) Includes 40 mm (1.5 in.) airspace at RSI 0.16 (R0.91), ASHRAE Handbook of Fundamentals 2009 SI
- 5) Path R-value through framing = Path R-value through insulation - Insulation Layer R-value + Framing Layer R-value
- 6) For the Thermal Metric research project Framing Factor = % Area of Framing = 13.7%; % Area of Insulation = 100 - % Area of Framing
- 7) Clear-Wall U-Value = (% Area Insulation / 100) / (Path R-Value through Insulation) + (% Area Framing / 100) / (Path R-Value through Framing)

Figure 45 presents a summary of common thermal metrics for Reference Walls 2, 7 and 8. **The impact of thermal bridging is evident when the Center-of-Cavity R-values (red bars) are compared to the Clear-Wall R-values (high k framing - green bars).** Thermal bridging through the regular framing elements (i.e. studs, top plates and bottom plates) reduces the assembly R-value by 17%, 11% and 20% for Walls 2, 7 and 8 respectively. Note that in Wall 7, thermal bridging is minimized by the exterior insulation.

In the above analysis, the Center-of-Cavity R-values assume a framing factor of 0.137 (i.e. the framing factor of the TM test wall specimens). Studies have shown that, when the full framing of a house is accounted for, the framing factor could be closer to 0.27². If this framing factor were applied, thermal bridging would reduce the assembly R-value by 29%, 20% and 34% for walls 2, 7 and 8 respectively.

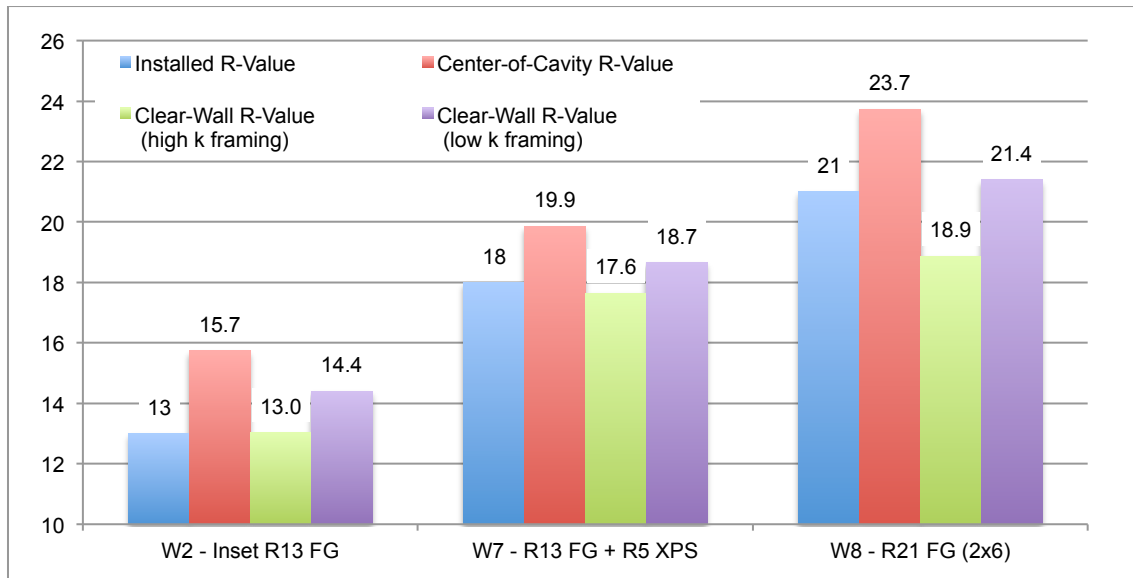

Figure 45 – Common Thermal Metrics for Reference Walls 2, 7 and 8

Figure 45 **also demonstrates the impact of material property variability.** The green bars represent the Clear-Wall R-values for spruce-pine-fir (S-P-F) framing that has a higher thermal conductivity (high k framing: e.g. $k = 0.15 \text{ W/m}\cdot\text{K}$ or $R1.0 / \text{in.}$) while the purple bars represent the Clear-Wall R-values for spruce-pine-fir framing that has a lower thermal conductivity (low k framing: e.g. $k = 0.076 \text{ W/m}\cdot\text{K}$ or $R1.9 / \text{in.}$) This range of thermal conductivity covers the range of wood densities and moisture content conditions measured in the Thermal Metric Reference Walls. The conductivity of natural materials can vary significantly. The conductivity of site-manufactured materials such as spray polyurethane foam (e.g. ocSPF or ccSPF) and spray-applied, dense-packed or blown fiber insulation (e.g. cellulose or glass fiber) can also vary. Researchers must quantify and document material-specific thermal conductivity and those properties that influence it (including density, moisture content, etc.). Designers and building scientists should be aware of this variability and its potential impact on the thermal performance of wall assemblies.

² Carpenter S.C., Schumacher C.J. "Characterization of Framing Factors for Wood-Framed Low-Rise Residential Buildings." ASHRAE Transactions v 109, Pt 1. Feb. 2003.

2.4 Temperature Dependency

The thermal conductivity of materials is also dependent on temperature. For most materials conductivity varies linearly with temperature (over the range of temperatures experienced by buildings). Typically, materials exhibit a higher thermal conductivity (and lower R-value / in.) at higher temperatures and a lower thermal conductivity (and higher R-value / in.) at lower temperatures.

Figure 46 plots the measured apparent R-value of an R13 fiber glass batt (at 3.5 in. thickness) over the temperature range that is tested in the Thermal Metric Hot Box (-28°C or -18°F to 62°C or 144°F). At 72°F (i.e. room temperature), the material exhibits an apparent R12.8; as the material is cooled to -18°F the apparent R-value increases 16% to approximately R14.9; as the material is heated from room temperature to 144°F the apparent R-value decreases 12% to roughly R11.3.

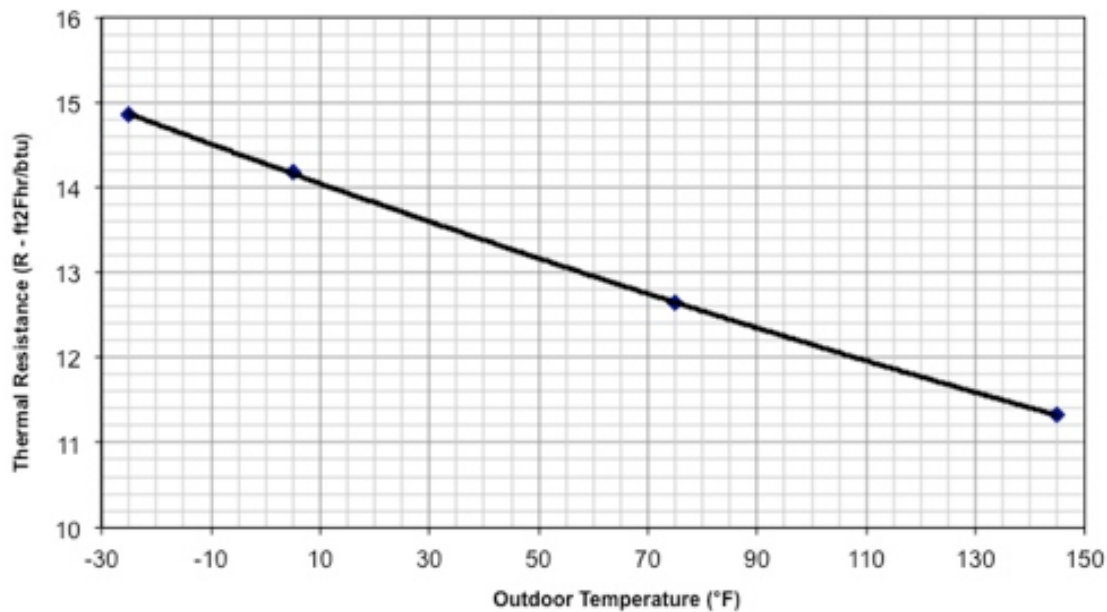

Figure 46 – Measured Temperature Dependency for an R13 fiber glass Batt

Different materials exhibit different temperature dependency. Porous, air-filled insulation materials tend to have steeper slopes than closed-pore, refrigerant-filled insulation materials. There are also some major exceptions; for example, some polyisocyanurate insulations used in the TM Research Project exhibit a sharp increase in thermal conductivity (and decrease in R-value / in.) as temperatures approach and go below freezing. Figure 47 plots the measured conductivity versus mean temperature for selected materials from the TM Research Project. The vertical dashed-line indicates a mean temperature of 75°F (23.9°C), the mean temperature at which insulation R-values are reported on consumer packaging.

Temperature dependent material conductivities (or R-value / in.) can be used to calculate Clear-Wall R-values over a range of temperatures. Figure 48 plots predicted and measured Clear-Wall R-values for Wall 2 – Inset-Stapled R13 Kraft-Faced fiber glass Batt. In this plot the dotted line represents the predicted Clear-Wall R-value assuming constant conductivity for each material; the dashed line represents the predicted Clear-Wall R-value when temperature dependency is accounted for; and the blue diamonds indicate the "sealed" assembly (i.e. Clear-Wall) R-values measured in the TM Hot Box.

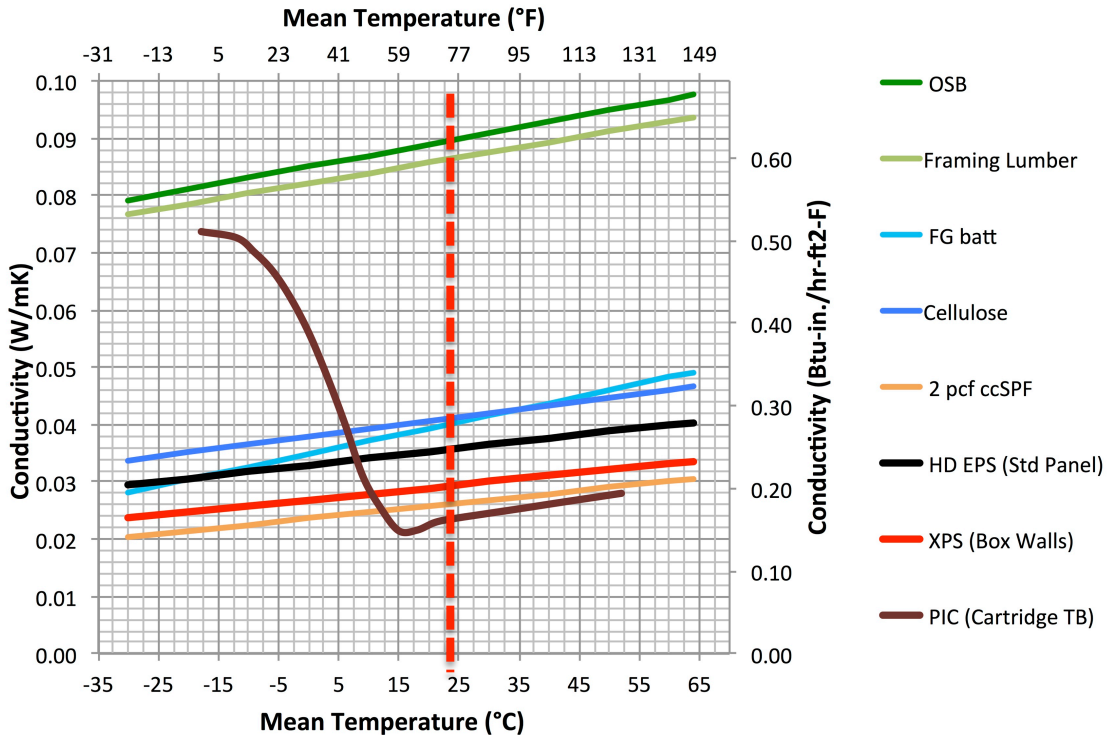

Figure 47 – Measured Temperature Dependency of Selected Materials from the TM Research Project

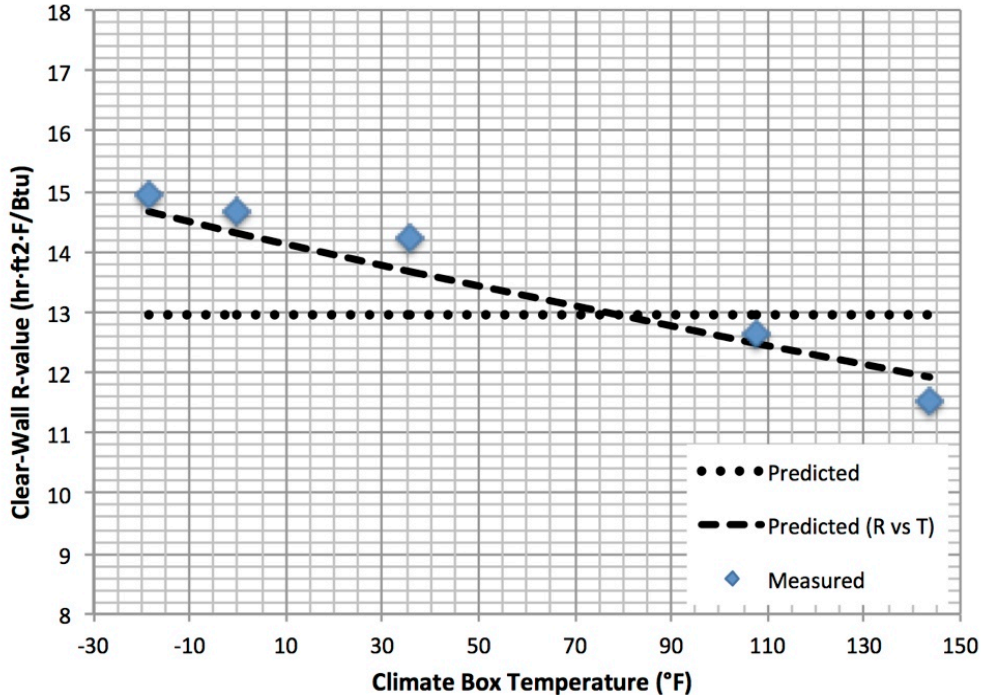

Figure 48 – Predicted and Measured Assembly Wall R-values (air-air) for Wall 2 – Inset- R13 FG Batt

Measured ‘sealed’ and ‘as-built’ reference wall assembly R-values are presented Section 3 of this report. Note that the reported R-values in Section 3 do not include R-values (i.e. they are based on surface-surface temperatures).

2.5 Air Leakage and Interaction

Air leakage always increases the total heat flow through the building enclosure. However, air interacts with the materials in an assembly as it travels through. This interaction changes the temperature field in the assembly and through an assembly. Air leakage interaction can be evaluated through a comparison of measured energy flows for various scenarios. Here follows a step-by-step analysis of the airflow interaction in Wall 2 – Inset-Stapled R13 Kraft-Faced fiber glass Batt.

Figure 49 presents the measured heat flows for the “sealed” scenario of Wall 2. In these tests the wall was “sealed” on the exterior and interior sides using polyethylene sheets and tape, in order to eliminate air leakage through the assembly. In these tests mass flow across the assembly (i.e. from indoors to outdoors or vice versa) is assumed to be none existent. These tests represent the “ideal” or minimum heat flows represented by the simple conduction-only building enclosure heat loss model of Figure 50. These tests provide a baseline for comparing the induced airflow tests.

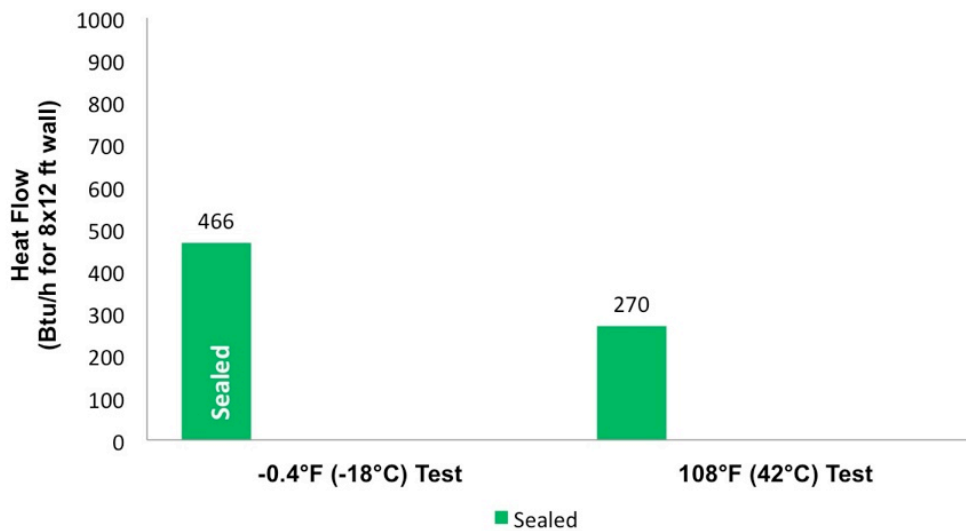

Figure 49 – Measured Heat flows for Wall 2 – Inset R13 FG batt, ‘Sealed’

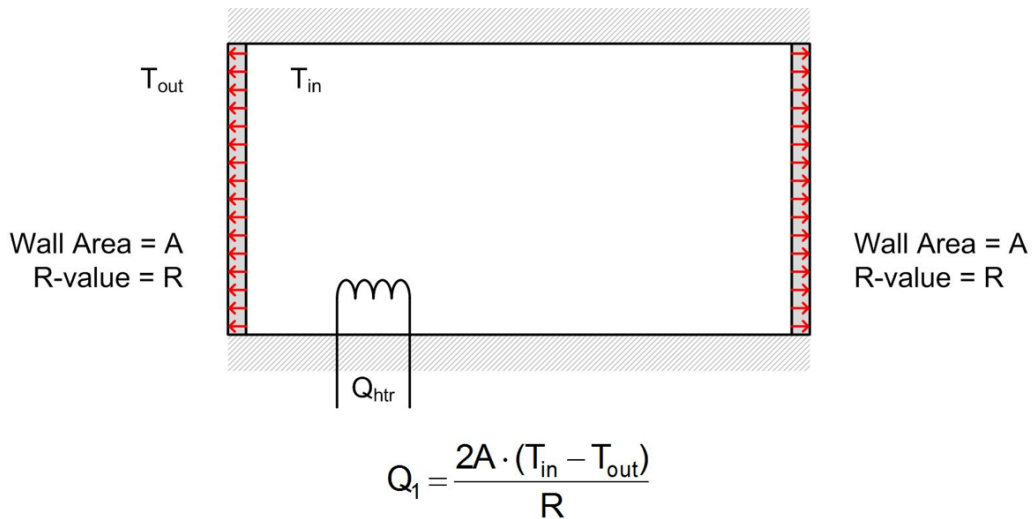

Figure 50 – Simple Conduction-Only Building Enclosure Heat Loss Model (i.e. no Air Leakage)

Figure 51 compares the measured heat flows for the “sealed” and “as-built” scenarios of Wall 2. The “as-built” test was conducted without any external poly seals; the airtightness of the test wall and any associated air leakage paths are dependent on the construction of the test wall specimen. The panel airtightness is a function of implemented air sealing strategies, workmanship, material properties, thermal expansion / contraction and other factors.

No intentional air pressure differentials were induced for the “as-built” wall tests, however temperature differences and circulation fans inevitably create small pressure differences (e.g. +/- 1 to 3 Pa) across the test wall assembly. Slightly higher heat flows were measured for the “as-built” tests. This may be evidence of small airflows driven by the unintentional pressure difference. In the TM Hot Box tests these small airflows are quantified using the CO₂ tracer gas system.

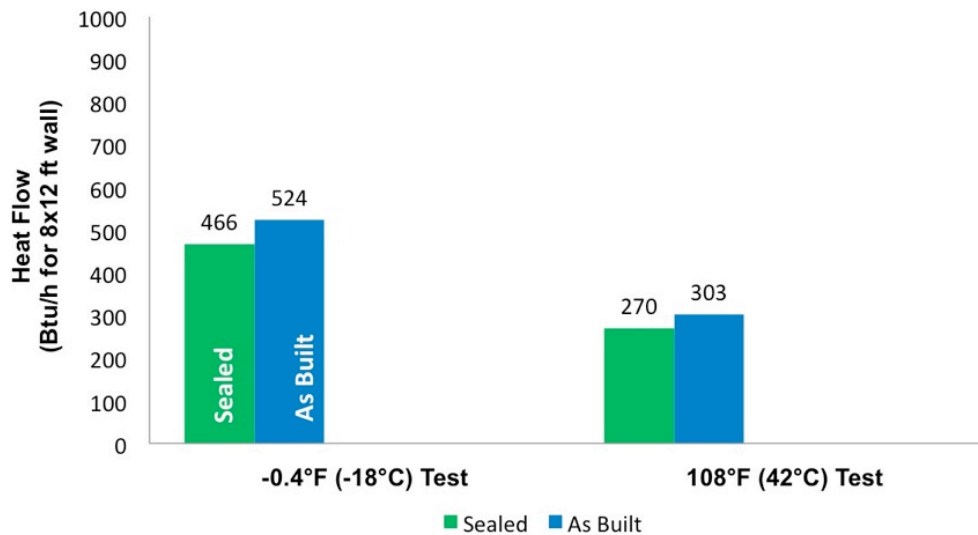

Figure 51 – Measured Heat flows for Wall 2 – Inset R13 FG batt, ‘Sealed’ vs ‘As-built’

2015-06-18 – Thermal Metric Summary Report (June 2015 Update)

The TM test procedure included 2 hot and 2 cold induced airflow tests. Positive and negative 10 Pa pressure differences were generated to induce exfiltration from and infiltration to the meter box. The air travels in a closed loop between the meter box and the climate box to ensure conservation of mass in the system. The resulting airflow was measured using mass flow sensors and the CO₂ tracer gas system.

Typical building enclosure heat loss models, such as the one represented in Figure 52, treat air leakage as if it occurs through discrete holes and does not interact with conductive heat flow through the assembly. This approach can be used to predict the energy associated with the airflows and temperature differences measured in the TM induced infiltration and exfiltration tests. The air leakage energy flow can then be added to the "sealed" heat flow to predict the total heat flow associated with the temperature difference and air leakage. These totals are represented by the red bars in Figure 53.

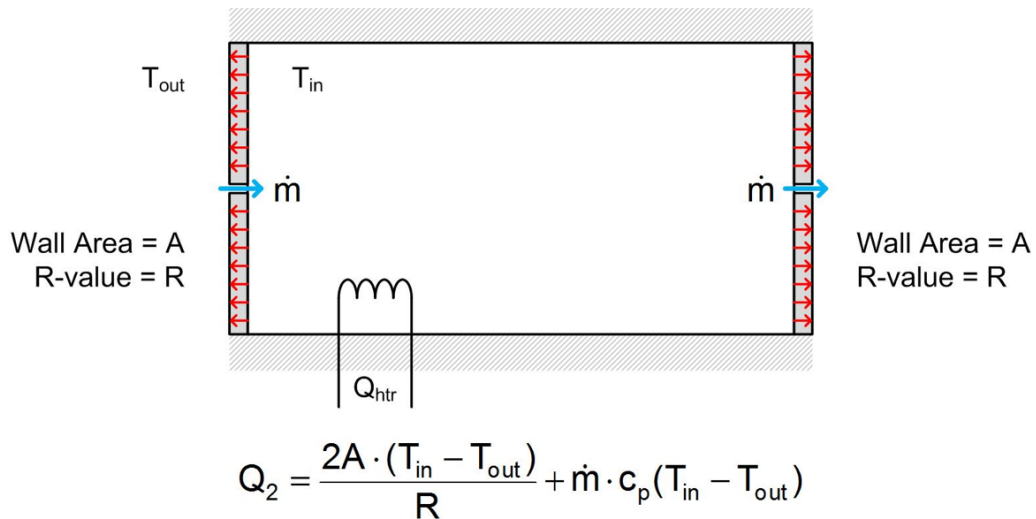

Figure 52 – Simple Building Enclosure Heat Loss Model with Discrete Air Leakage

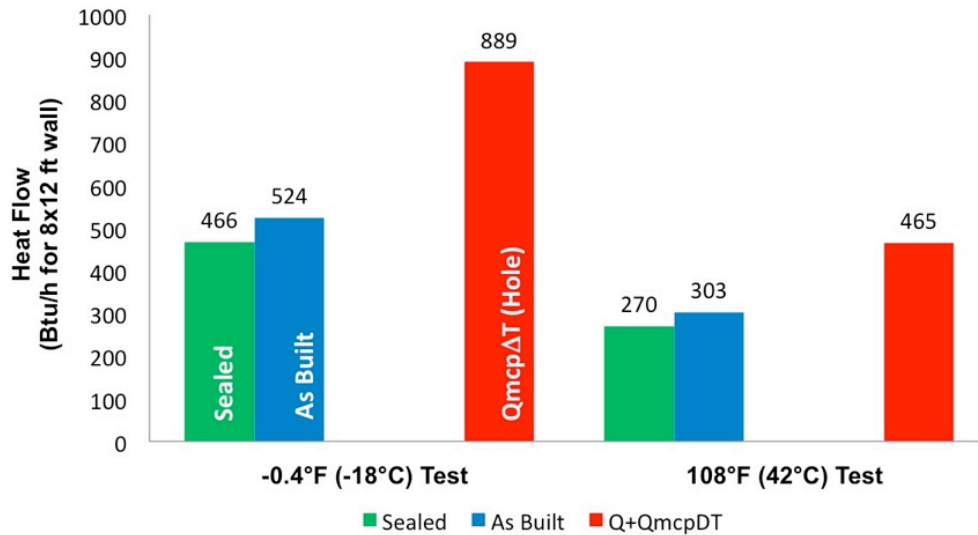

Figure 53 – Measured Heat Flows vs Predicted Airflow Impact for Wall 2 – Inset R13 FG batt

The TM reference wall test results show strong evidence of the interaction between conductive and convective heat flows. Figure 54 presents a simplified building model with equal areas of wall on the windward and leeward side of the building. The windward walls experience infiltration while the leeward walls experience exfiltration. Interaction results in heat exchange between the air and the materials inside the wall assembly and the total measured heat flow (represented by the brown bar in Figure 55) is less than predicted by the commonly used discrete air leakage model (represented by the red bar in Figure 55).

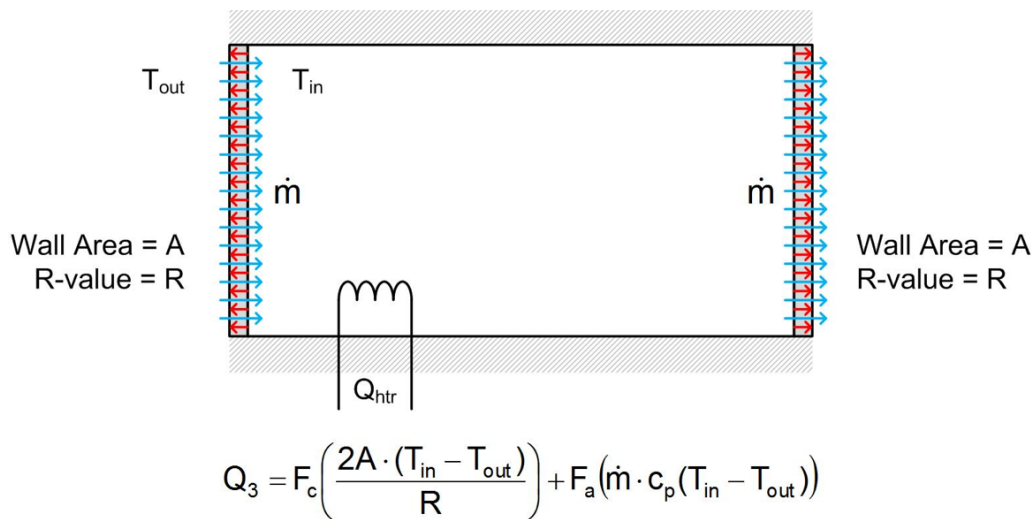

Figure 54 – Simplified Building Model for Interaction given Equal Infiltration & Exfiltration

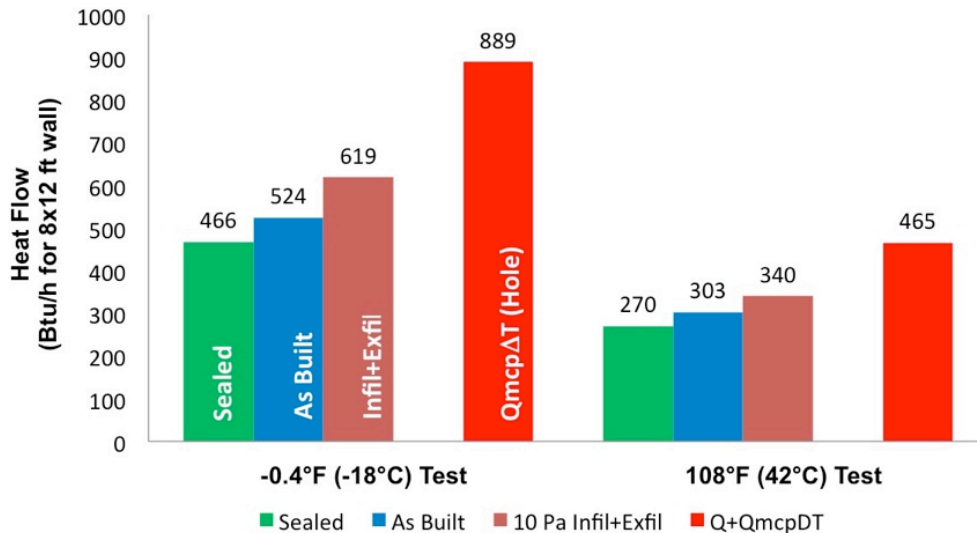

Figure 55 – Infiltration + Exfiltration Building Scenario for Wall 2 – Inset R13 FG batt

Figure 56 presents a simplified model for a different scenario. In this building a large mechanical exhaust removes air without any heat recovery (i.e. no interaction). As a result, the building is negatively pressurized and air infiltrates in both exterior walls. Again, interaction results in heat exchange between the air and the materials inside the wall and the total measured heat flow (represented by the purple bar in Figure 57) is less than predicted by the commonly used discrete air leakage model (represented by the red bar in Figure 57).

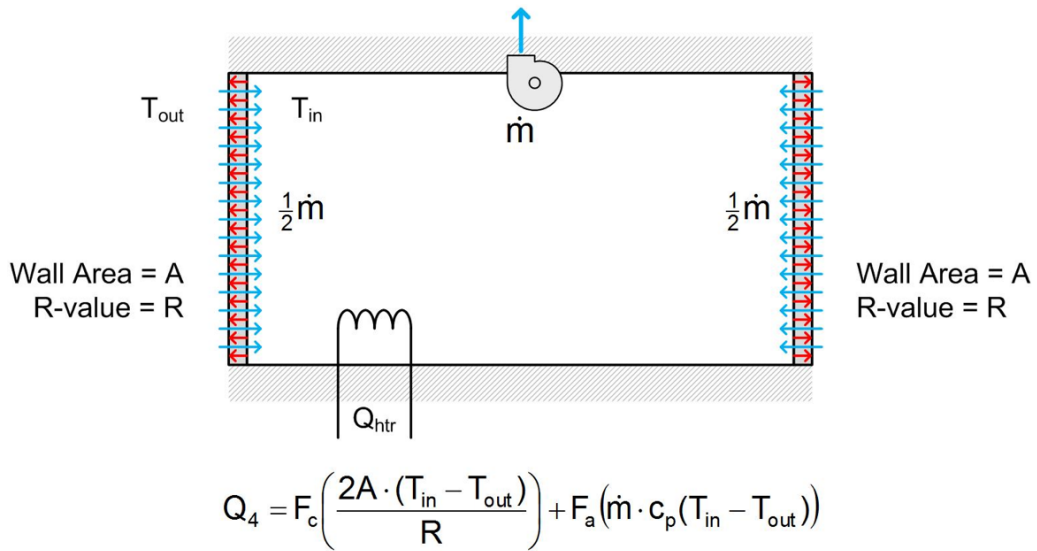

Figure 56 – Simplified Building Model for Interaction given Infiltration Only

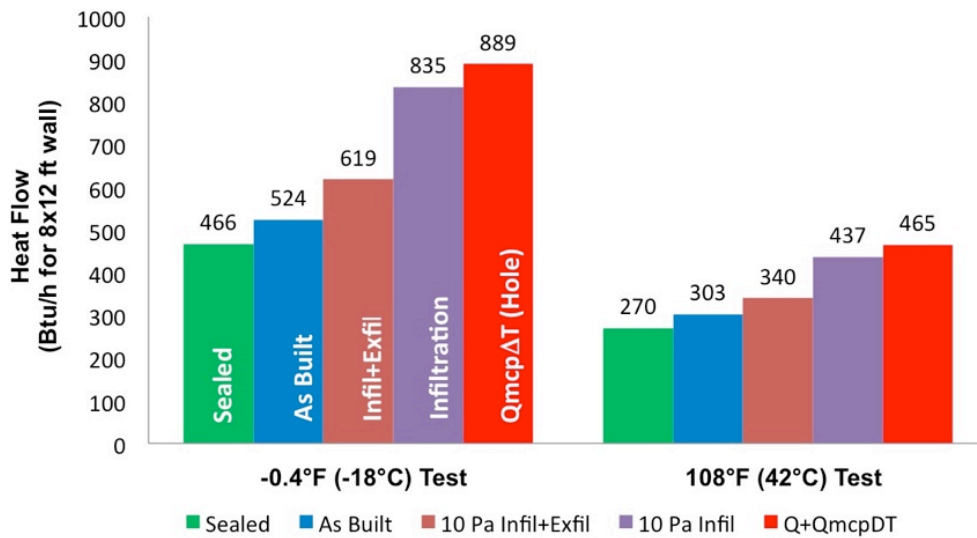

Figure 57 – Infiltration Only Building Scenario for Wall 2 – Inset R13 FG batt

3 Results

The results of the reference wall tests were analyzed using the concepts and methods presented in Section 2. The results reported below.

3.1 Intentionally Blank

This section was intentionally left blank so section numbering coincides with wall numbering.

3.2 Reference Wall 2 – Inset-Stapled R13 Kraft-Faced Fiber Glass Batt

Wall Name:	Reference Wall 2 – Inset Stapled F.G. Batt	Build Date:	January, 2011
Reference Wall 2 comprises 2x4" S-P-F wood stud wall at 16" centers with inset-stapled, kraft faced, R-13 fibre glass batt insulation. The wall was sheathed with 7/16" OSB sheathing.		Test Date:	January, 2011
		Researchers:	C. J. Schumacher A. P. Grin, P.Eng. R. T. Lepage, E.I.T.
Wall Dimensions	H: 2413mm (95.0"); L: 3635mm (143.125")		
Wall Area:	8.775m ² (94.42 sq.ft)		
Interior Finish	½" Drywall with 1/32" gap provided by machined shims		
Inside Air Seal	None		
Frame	2x4 S-P-F wood studs at 16" OC		
Electrical	Two outlets and one switch, with wiring		
Insulation	3.5" R-13 kraft faced fibre glass batt insulation		
Sheathing	7/16" OSB with 1/32" gap provided by machined shims		
Outside Air Seal	None		
WRB 1	Tyvek Housewrap		
Ext. Insulation	None		
WRB 2	None		
Drainspace	Integral in cladding		
Cladding	Vinyl Siding		
Framing Notes	2x4" S-P-F framing at 16" OC, double top plate, single bottom plate, and ½ width studs on edges		
Framing Factor	13.7%		

3.2.1 Material Properties

Material	Density		Moisture Content (%wt)	Conductivity, k (Wm ² ·K/W)	R-Value / in. (Ft ² ·F·h/Btu·in)
	(kg/m ³)	(pcf)			
OSB Sheathing	599 ²	31.2	6-8% ²	0.0897 @ 23.9°C ³	1.61 @ 75°F ³
Spruce-Pine-Fir Framing	400 ¹	25	5-9% ²	0.0864 @ 23.9°C ³	1.67 @ 75°F ³
R-13 Kraft Faced Fiber Glass Batt	11.7 ⁴	0.73 ⁴	-	0.0363 @ 2°C ⁴ 0.0408 @ 23.9°C ⁴ 0.0426 @ 32°C ⁴	3.97 @ 35.6°F ⁴ 3.53 @ 75°F ⁴ 3.39 @ 89.6°F ⁴
Drywall	660 ²	41.3	-	0.146 @ 23.9°C ³	0.988 @ 75°F ³

- Notes:
- 1) Assumed from ASHRAE Handbook of Fundamentals 2009
 - 2) Measured at Building Science Labs; random sampling of material lots purchased for multiple wall specimens
 - 3) Measured at Building Science Labs (ASTM C518); random sampling of material lot; conductivity and R-value reported at mean temperature indicated
 - 4) Measured at Building Science Labs (ASTM C518); sampling of actual insulation materials from the test wall specimen; conductivity and R-value reported at mean temperature indicated

3.2.2 Schematics

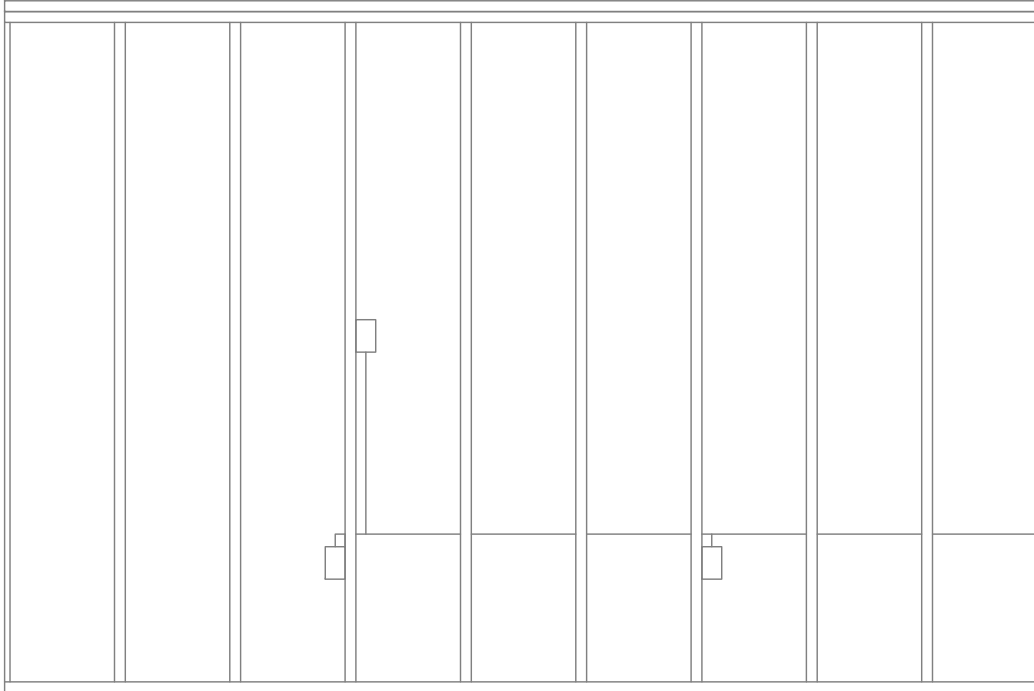

Figure 58 – Elevation of Framing & Electrical for Reference Wall 2 – Inset-Stapled F.G. Batt

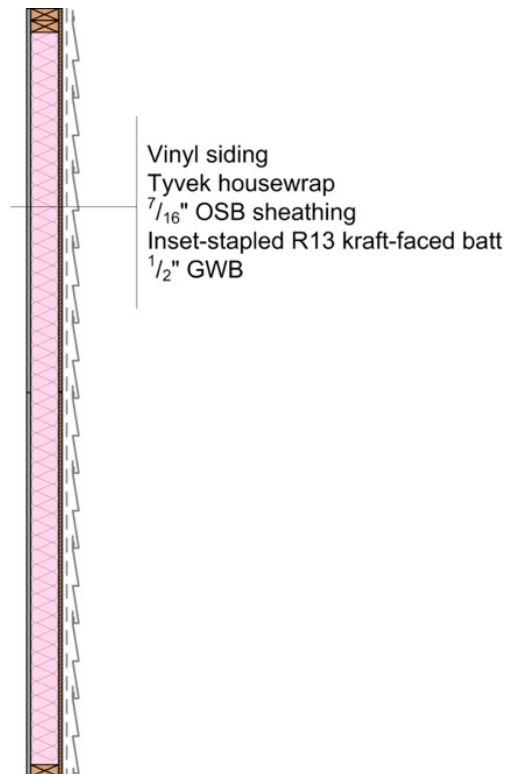
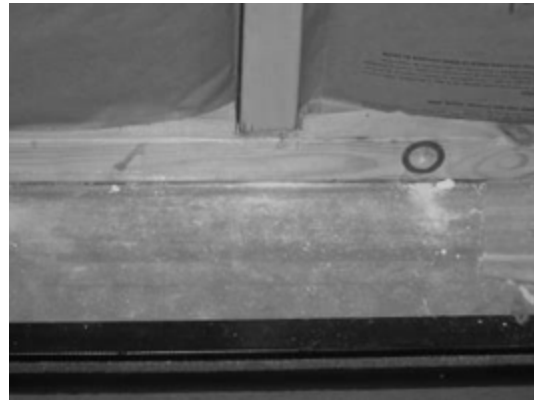

Figure 59 – Vertical Section for Reference Wall 2 - Inset-Stapled F.G. Batt

3.2.3 Notes

Pre-Construction	<ul style="list-style-type: none"> BSCI staff pre-assembled the wall frame and sheathing and seasoned it at lab conditions (20-23°C and 30-60% RH) for a period of 6 months prior to construction of the test wall specimen.
Construction	<ul style="list-style-type: none"> An industry partner with expertise in fiber glass insulation was on site to instruct BSCI staff on the proper methods to install face-stapled fiber glass batt insulation.
Testing	<ul style="list-style-type: none"> No comments
Decommissioning	<ul style="list-style-type: none"> When all 14 test segments were completed, BSCI staff removed Reference Wall 2 from the hot box and removed the batt insulations for inspection. Samples of the wall specimen were taken for thermal conductivity testing.
General	<ul style="list-style-type: none"> The reference wall performed as anticipated.

3.2.4 Photos



3.2.5 Test Results

Wall 2– 2x4 Face-Stapled F.G. Batt: Air Flow Testing

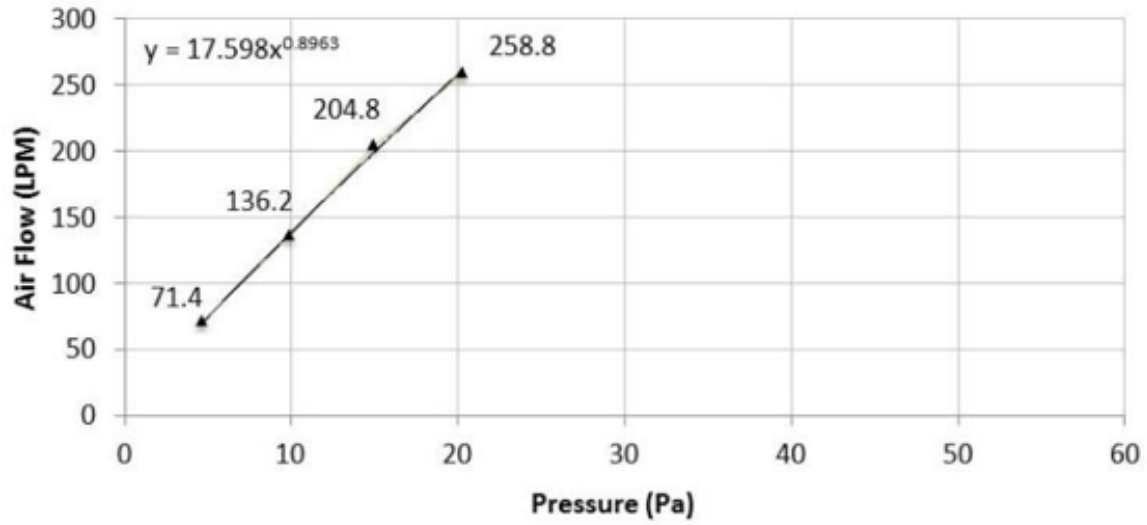

2015-06-18 – Thermal Metric Summary Report (June 2015 Update)

The results from the testing, at the specified temperature setpoints, are provided below. MB refers to the meter box; CB refers to the climate box.

Ref Wall 2 Inset-Stacked R13 FG batt (‘as-built’)		Test Regime (Interior Exterior Induced Airflow)					Induced Airflows (10Pa)			
	Units	22 62 none	22 42 none	22 2 none	22 -18 none	22 -28 none	22 -18 Inf	22 -18 Exf	22 42 Inf	22 42 Exf
Start Date	YY/MM/DD	11/02/04	11/03/22	11/01/26	11/03/28	11/03/31	11/03/30	11/03/30	11/03/26	11/03/25
End Date	YY/MM/DD	11/02/08	11/03/24	11/01/28	11/03/29	11/04/01	11/03/30	11/03/31	11/03/27	11/03/26
MB- Air Temp	C	21.96	21.87	21.58	21.29	21.19	21.13	21.43	21.96	21.90
CB- Air Temp	C	62.04	42.02	1.96	-18.21	-27.99	-17.74	-17.91	42.03	42.03
MB- Surf Temp	C	24.75	23.34	20.52	19.27	18.74	18.64	19.68	23.67	23.11
CB- Surf Temp	C	60.29	41.28	2.71	-16.50	-25.89	-16.30	-15.82	41.35	41.06
S-S Temp	C	35.54	17.94	-17.81	-35.77	-44.63	-34.94	-35.50	17.68	17.95
Q- Measured	W	-196.07	-93.75	86.36	168.75	206.69	259.60	134.65	-133.00	-81.77
Q-Air	W	4.13	1.79	-10.02	-19.38	-30.50	123.97	-114.17	-57.17	56.56
Q-Flanking	W	10.25	4.95	-5.06	-15.12	-20.72	-14.88	-15.06	4.93	4.94
Q -TAS	W	NA	NA	NA	NA	NA	-1.68	-1.69	0.07	5.60
Q-Final	W	-185.82	-88.80	81.30	153.63	185.97	244.72	117.90	-128.07	-71.23
RSI*	W·m ⁻² ·K ⁻¹	1.68	1.77	1.92	2.04	2.11	1.25	2.64	1.21	2.21
R-Value*	ft ² ·F·h·Btu ⁻¹	9.53	10.07	10.92	11.60	11.96	7.11	15.00	6.88	12.56

*Thermal resistance calculated by dividing the total corrected heat flow by the surface area of the sample and the surface temperature differentials between the meter box and the climate box.

Ref Wall 2 Inset-Stacked R13 FG batt (‘Sealed 2 sides’)		Test Regime (Interior Exterior Induced Airflow)				
	Units	22 62 none	22 42 none	22 2 none	22 -18 none	22 -28 none
Start Date	YY/MM/DD	11/04/12	11/04/11	11/04/08	11/04/05	11/04/05
End Date	YY/MM/DD	11/04/13	11/04/12	11/04/11	11/04/05	11/04/06
MB- Air Temp	C	21.91	21.85	21.57	21.29	21.18
CB- Air Temp	C	62.08	42.03	2.02	-18.02	-27.98
MB- Surf Temp	C	25.29	23.51	20.38	18.98	18.38
CB- Surf Temp	C	59.60	40.83	3.21	-15.48	-24.71
S-S Temp	C	34.30	17.32	-17.17	-34.46	-43.09
Q- Measured	W	-184.38	-84.14	75.54	151.78	188.24
Q-Air	W	0.43	0.21	-0.21	-0.42	-0.53
Q-Flanking	W	10.28	4.95	-5.04	-15.05	-20.71
Q -TAS	W	NA	NA	NA	NA	NA
Q-Final	W	-174.10	-79.18	70.50	136.73	167.53
RSI*	W·m ⁻² ·K ⁻¹	1.73	1.92	2.14	2.21	2.26
R-Value*	ft ² ·F·h·Btu ⁻¹	9.82	10.90	12.14	12.56	12.82

2015-06-18 – Thermal Metric Summary Report (June 2015 Update)

Ref Wall 2 Inset-Stapled R13 FG batt (‘as-built’)		Test Regime (Interior Exterior Induced Airflow)					Induced Airflows (10Pa)			
	Units	22 62 none	22 42 none	22 2 none	22 -18 none	22 -28 none	22 -18 Inf	22 -18 Exf	22 42 Inf	22 42 Exf
Start Date	YY/MM/DD	11/02/04	11/03/22	11/01/26	11/03/28	11/03/31	11/03/30	11/03/30	11/03/26	11/03/25
End Date	YY/MM/DD	11/02/08	11/03/24	11/01/28	11/03/29	11/04/01	11/03/30	11/03/31	11/03/27	11/03/26
MB- Air Temp	F	71.53	71.37	70.84	70.32	70.15	70.03	70.58	71.52	71.42
CB- Air Temp	F	143.67	107.64	35.54	-0.78	-18.38	0.06	-0.23	107.65	107.65
MB- Surf Temp	F	76.55	74.02	68.94	66.68	65.73	65.56	67.43	74.61	73.59
CB- Surf Temp	F	140.52	106.31	36.88	2.30	-14.60	2.67	3.53	106.43	105.91
S-S Temp	F	63.49	31.99	-31.47	-63.13	-78.69	-61.13	-63.05	31.47	32.02
Q- Measured	Btu/h	-668.96	-319.84	294.63	575.74	705.18	885.70	459.39	-453.77	-278.99
Q-Air	Btu/h	14.08	6.08	-34.14	-66.04	-103.93	422.44	-389.06	-194.81	192.72
Q-Flanking	Btu/h	34.98	16.89	-17.25	-51.60	-70.69	-50.78	-51.39	16.82	16.87
Q -TAS	Btu/h	NA	NA	NA	NA	NA	-5.72	-5.75	0.24	19.11
Q-Final	Btu/h	-633.99	-302.95	277.38	524.14	634.49	834.92	402.24	-436.95	-243.02
RSI*	W·m ⁻² ·K ⁻¹	1.68	1.77	1.92	2.04	2.11	1.25	2.64	1.21	2.21
R-Value*	ft ² ·F·h·Btu ⁻¹	9.53	10.07	10.92	11.60	11.96	7.11	15.00	6.88	12.56

*Thermal resistance calculated by dividing the total corrected heat flow by the surface area of the sample and the surface temperature differentials between the meter box and the climate box.

Ref Wall 2 Inset-Stapled R13 FG batt (‘Sealed 2 sides’)		Test Regime (Interior Exterior Induced Airflow)				
	Units	22 62 none	22 42 none	22 2 none	22 -18 none	22 -28 none
Start Date	YY/MM/DD	11/04/12	11/04/11	11/04/08	11/04/05	11/04/05
End Date	YY/MM/DD	11/04/13	11/04/12	11/04/11	11/04/05	11/04/06
MB- Air Temp	F	71.43	71.34	70.83	70.31	70.13
CB- Air Temp	F	143.75	107.65	35.64	-0.44	-18.37
MB- Surf Temp	F	77.53	74.31	68.68	66.16	65.08
CB- Surf Temp	F	139.28	105.49	37.77	4.13	-12.48
S-S Temp	F	61.33	30.96	-30.44	-61.03	-76.26
Q- Measured	Btu/h	-629.06	-287.05	257.73	517.84	642.23
Q-Air	Btu/h	1.46	0.73	-0.71	-1.43	-1.79
Q-Flanking	Btu/h	35.06	16.90	-17.20	-51.35	-70.67
Q -TAS	Btu/h	NA	NA	NA	NA	NA
Q-Final	Btu/h	-594.00	-270.15	240.53	466.49	571.56
RSI*	W·m ⁻² ·K ⁻¹	1.73	1.92	2.14	2.21	2.26
R-Value*	ft ² ·F·h·Btu ⁻¹	9.82	10.90	12.14	12.56	12.82

Wall 2: R-Value– Sealed and As-Built

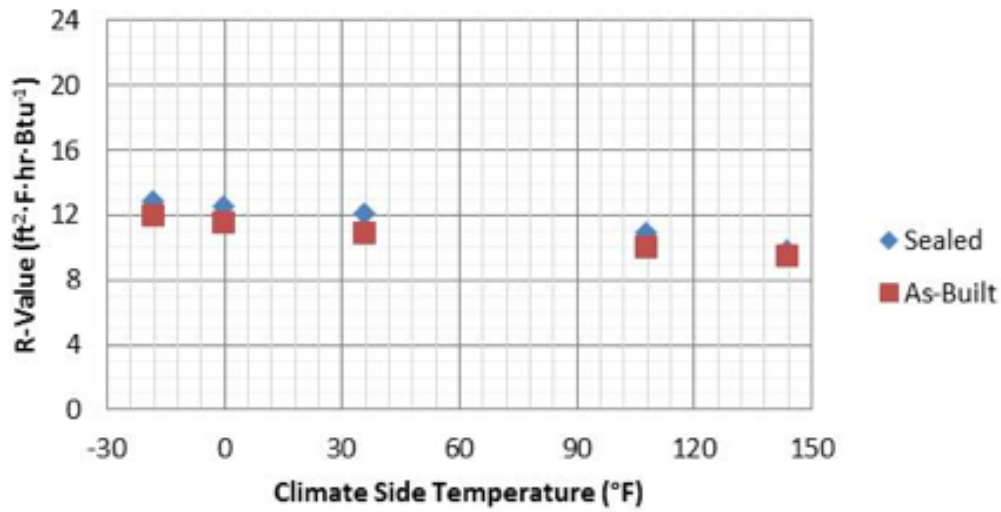

Wall 2: U-Value (Surface to Surface)

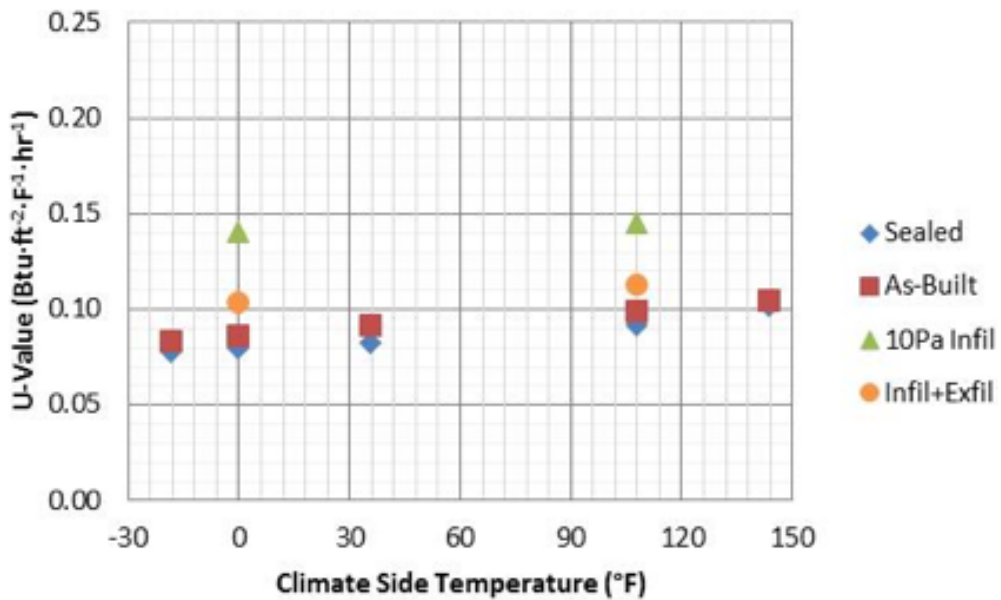

Wall 2: Building Energy Use per Wall

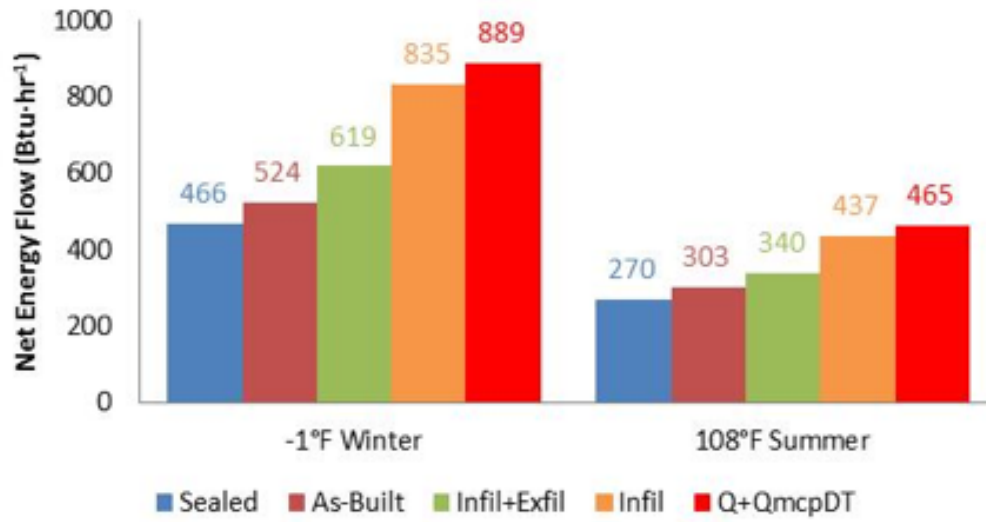

3.3 Reference Wall 3 – Face-Stapled R13 Kraft-faced Fiber Glass Batt

Wall Name:	Reference Wall 3 – Face-Stapled F.G. Batt	Build Date:	April, 2011
Reference Wall 3 comprises 2x4" S-P-F wood stud wall at 16" centers with face-stapled, kraft faced, R-13 fibre glass batt insulation. The wall was sheathed with 7/16" OSB sheathing.		Test Date:	April, 2011
		Researchers:	C. J. Schumacher A. P. Grin, P.Eng. R. T. Lepage, E.I.T.
Wall Dimensions	H: 2413mm (95.0"); L: 3635mm (143.125")		
Wall Area:	8.775m ² (94.42 sq.ft)		
Interior Finish	½" Drywall with 1/32" gap provided by machined shims		
Inside Air Seal	None		
Frame	2x4 S-P-F wood studs at 16" OC		
Electrical	Two outlets and one switch, with wiring		
Insulation	3.5" R-13 kraft faced fibre glass batt insulation		
Sheathing	7/16" OSB with 1/32" gap provided by machined shims		
Outside Air Seal	None		
WRB 1	Tyvek Housewrap		
Ext. Insulation	None		
WRB 2	None		
Drainspace	Integral in cladding		
Cladding	Vinyl Siding		
Framing Notes	2x4" S-P-F framing at 16" OC, double top plate, single bottom plate, and ½ width studs on edges		
Framing Factor	13.7%		

3.3.1 Material Properties

Material	Density		Moisture Content (%wt)	Conductivity, k (Wm ² ·K/W)	R-Value / in. (Ft ² ·F·h/Btu·in)
	(kg/m ³)	(pcf)			
OSB Sheathing	599 ²	31.2	6-8% ²	0.0897 @ 23.9°C ³	1.61 @ 75°F ³
Spruce-Pine-Fir Framing	400 ¹	25	5-9% ²	0.0864 @ 23.9°C ³	1.67 @ 75°F ³
R-13 Kraft Faced Fiber Glass Batt	10.8 ⁴	0.68 ⁴	-	0.0358 @ 2°C ⁴ 0.0402 @ 23.9°C ⁴ 0.0420 @ 32°C ⁴	4.02 @ 35.6°F ⁴ 3.59 @ 75°F ⁴ 3.43 @ 89.6°F ⁴
Drywall	660 ²	41.3	-	0.146 @ 23.9°C ³	0.988 @ 75°F ³

- Notes:
- 1) Assumed from ASHRAE Handbook of Fundamentals 2009
 - 2) Measured at Building Science Labs; random sampling of material lots purchased for multiple wall specimens
 - 3) Measured at Building Science Labs (ASTM C518); random sampling of material lot; conductivity & R-value reported at mean temperature indicated
 - 4) Measured at Building Science Labs (ASTM C518); sampling of actual insulation materials from the test wall specimen; conductivity and R-value reported at mean temperature indicated

3.3.2 Schematics

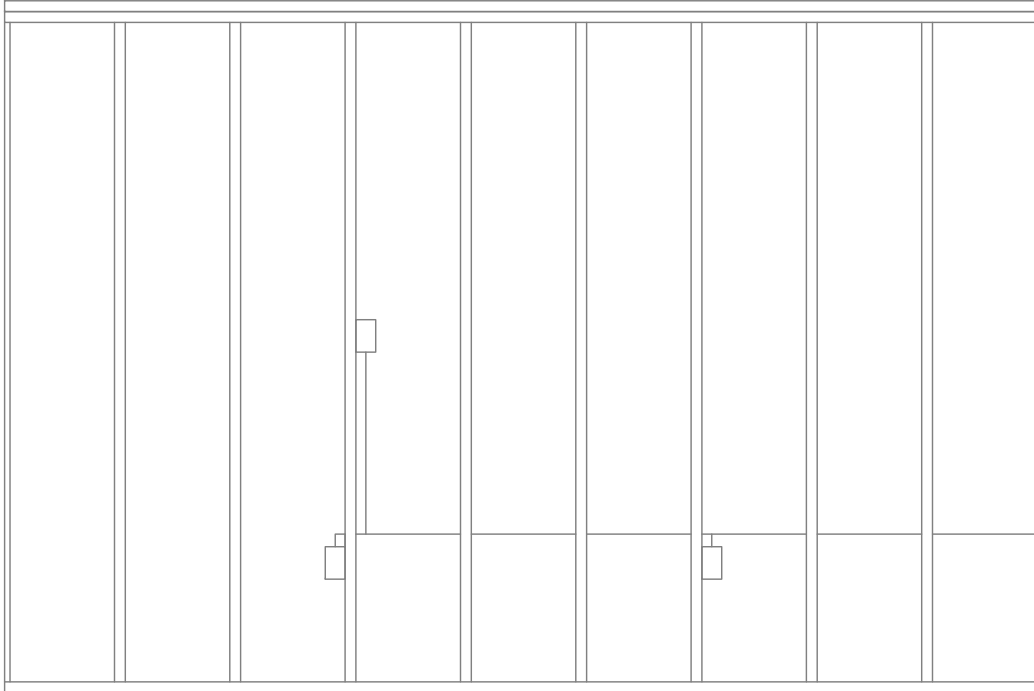

Figure 60 – Elevation of Framing & Electrical for Reference Wall 3 – 2x4 Face-Stapled F.G. Batt

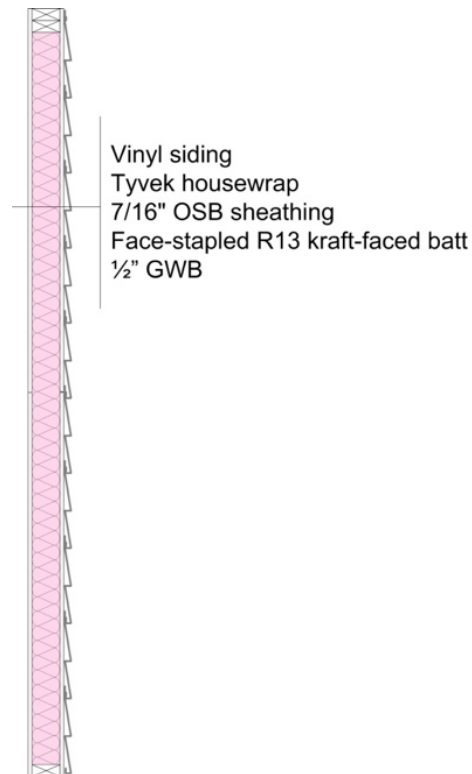
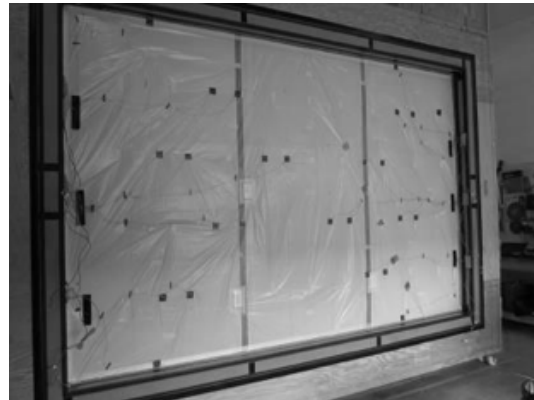
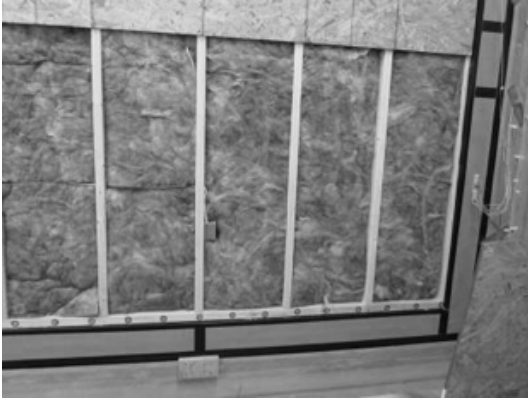

Figure 61 – Vertical Section for Reference Wall 3 – 2x4 Face-Stapled F.G. Batt

3.3.3 Notes

Pre-Construction	<ul style="list-style-type: none"> Wall 3 was modified from Wall2.
Construction	<ul style="list-style-type: none"> After testing Wall2, BSCI staff carefully removed the GWB and fiber glass batt insulation. BSCI staff carefully fitted Wall 3 fiber glass batt per NAIMA recommendations, as instructed by the industry partner who provided expertise for Wall 2. The kraft-facer was face-stapled to the indoor side of the studs. No industry partners were present to observe the installation.
Testing	<ul style="list-style-type: none"> No comments
Decommissioning	<ul style="list-style-type: none"> Samples of the wall specimen were taken for thermal conductivity testing.
General	<ul style="list-style-type: none"> The reference wall performed as anticipated.

3.3.4 Photos



3.3.5 Test Results

Wall 3- 2x4 Inset-Stapled F.G. Batt: Air Flow Testing

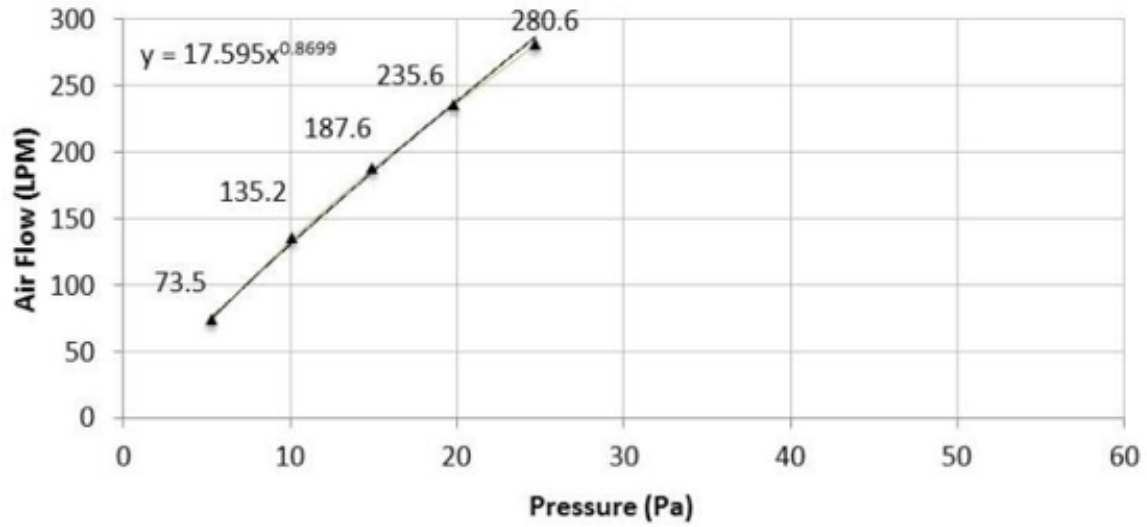

2015-06-18 – Thermal Metric Summary Report (June 2015 Update)

The results from the testing, at the specified temperature setpoints, are provided below. MB refers to the meter box; CB refers to the climate box.

Ref Wall 3 Face-Stapled R13 FG batt (‘as-built’)		Test Regime (Interior Exterior Induced Airflow)					Induced Airflows (10Pa)			
	Units	22 62 none	22 42 none	22 2 none	22 -18 none	22 -28 none	22 -18 Inf	22 -18 Exf	22 42 Inf	22 42 Exf
Start Date	YY/MM/DD	11/05/06	11/04/30	11/04/16	11/04/19	11/04/27	11/04/21	11/04/25	11/05/03	11/05/04
End Date	YY/MM/DD	11/05/09	11/05/01	11/04/19	11/04/20	11/04/29	11/04/23	11/04/27	11/05/04	11/05/05
MB- Air Temp	C	21.91	21.87	21.57	21.29	21.14	21.15	21.36	21.90	21.83
CB- Air Temp	C	62.02	42.05	1.98	-17.97	-27.96	-17.96	-17.97	42.05	42.05
MB- Surf Temp	C	24.68	23.29	20.39	19.05	18.41	18.64	19.44	23.54	23.03
CB- Surf Temp	C	60.34	41.33	2.69	-16.47	-26.09	-16.63	-16.04	41.35	41.07
S-S Temp	C	35.66	18.04	-17.69	-35.51	-44.50	-35.26	-35.48	17.81	18.04
Q- Measured	W	-193.60	-91.89	81.03	159.95	197.41	242.74	130.12	-137.94	-87.10
Q-Air	W	4.88	2.27	-5.33	-15.33	-22.04	111.15	-104.12	-50.38	49.98
Q-Flanking	W	10.26	4.96	-5.05	-15.03	-20.69	-14.98	-15.06	4.95	4.97
Q -TAS	W	NA	NA	NA	NA	NA	0.00	0.88	0.02	5.93
Q-Final	W	-183.33	-86.93	75.98	144.92	176.72	227.76	115.94	-132.99	-76.20
RSI*	W·m ⁻² ·K ⁻¹	1.71	1.82	2.04	2.15	2.21	1.36	2.69	1.18	2.08
R-Value*	ft ² ·F·h·Btu ⁻¹	9.69	10.34	11.60	12.21	12.55	7.71	15.25	6.67	11.79

*Thermal resistance calculated by dividing the total corrected heat flow by the surface area of the sample and the surface temperature differentials between the meter box and the climate box.

Ref Wall 3 Face-Stapled R13 FG batt (‘Sealed 2 sides’)		Test Regime (Interior Exterior Induced Airflow)				
	Units	22 62 none	22 42 none	22 2 none	22 -18 none	22 -28 none
Start Date	YY/MM/DD	11/05/17	11/05/19	11/05/11	11/05/13	11/05/14
End Date	YY/MM/DD	11/05/18	11/05/20	11/05/12	11/05/14	11/05/16
MB- Air Temp	C	21.90	21.84	21.58	21.26	21.19
CB- Air Temp	C	62.02	42.03	2.03	-17.97	-27.96
MB- Surf Temp	C	25.40	23.55	20.12	18.41	17.66
CB- Surf Temp	C	59.61	40.87	3.25	-15.86	-24.64
S-S Temp	C	34.21	17.32	-16.87	-34.28	-42.30
Q- Measured	W	-184.78	-88.49	74.89	144.58	177.85
Q-Air	W	0.43	0.22	-0.21	-0.42	-0.53
Q-Flanking	W	10.26	4.96	-5.04	-15.02	-20.71
Q -TAS	W	NA	NA	NA	NA	NA
Q- Final	W	-174.51	-83.53	69.85	129.55	157.14
RSI*	W·m ⁻² ·K ⁻¹	1.72	1.82	2.12	2.32	2.36
R-Value*	ft ² ·F·h·Btu ⁻¹	9.77	10.33	12.03	13.18	13.41

2015-06-18 – Thermal Metric Summary Report (June 2015 Update)

Ref Wall 3 Face-Stapled R13 FG batt (‘as-built’)		Test Regime (Interior Exterior Induced Airflow)					Induced Airflows (10Pa)			
	Units	22 62 none	22 42 none	22 2 none	22 -18 none	22 -28 none	22 -18 Inf	22 -18 Exf	22 42 Inf	22 42 Exf
Start Date	YY/MM/DD	11/05/06	11/04/30	11/04/16	11/04/19	11/04/27	11/04/21	11/04/25	11/05/03	11/05/04
End Date	YY/MM/DD	11/05/09	11/05/01	11/04/19	11/04/20	11/04/29	11/04/23	11/04/27	11/05/04	11/05/05
MB- Air Temp	F	71.43	71.37	70.82	70.32	70.06	70.08	70.45	71.43	71.29
CB- Air Temp	F	143.64	107.70	35.57	-0.35	-18.34	-0.34	-0.34	107.69	107.69
MB- Surf Temp	F	76.43	73.92	68.70	66.28	65.14	65.55	66.99	74.37	73.46
CB- Surf Temp	F	140.61	106.40	36.85	2.36	-14.96	2.07	3.12	106.43	105.92
S-S Final	F	63.57	32.15	-31.32	-62.77	-78.61	-62.20	-62.83	31.97	32.06
Q- Measured	Btu/h	-660.51	-313.51	276.46	545.72	673.51	828.17	443.94	-470.62	-297.16
Q-Air	Btu/h	16.63	7.75	-18.17	-52.25	-75.09	378.75	-354.81	-171.67	170.30
Q-Flanking	Btu/h	35.01	16.91	-17.23	-51.29	-70.59	-51.10	-51.38	16.88	16.94
Q -TAS	Btu/h	NA	NA	NA	NA	NA	0.00	3.01	0.07	20.24
Q- Final	Btu/h	-625.50	-296.60	259.23	494.44	602.93	777.06	395.58	-453.74	-259.98
RSI*	W·m ⁻² ·K ⁻¹	1.71	1.82	2.04	2.15	2.21	1.36	2.69	1.18	2.08
R-Value*	ft ² ·F·h·Btu ⁻¹	9.69	10.34	11.60	12.21	12.55	7.71	15.25	6.67	11.79

*Thermal resistance calculated by dividing the total corrected heat flow by the surface area of the sample and the surface temperature differentials between the meter box and the climate box.

Ref Wall 3 Face-Stapled R13 FG batt (‘Sealed 2 sides’)		Test Regime (Interior Exterior Induced Airflow)				
	Units	22 62 none	22 42 none	22 2 none	22 -18 none	22 -28 none
Start Date	YY/MM/DD	11/05/17	11/05/19	11/05/11	11/05/13	11/05/14
End Date	YY/MM/DD	11/05/18	11/05/20	11/05/12	11/05/14	11/05/16
MB- Air Temp	F	71.42	71.31	70.85	70.27	70.15
CB- Air Temp	F	143.63	107.66	35.65	-0.34	-18.33
MB- Surf Temp	F	77.72	74.39	68.21	65.14	63.79
CB- Surf Temp	F	139.30	105.56	37.85	3.44	-12.34
S-S Temp	F	61.58	31.17	-30.36	-61.70	-76.14
Q- Measured	Btu/h	-630.42	-301.90	255.50	493.26	606.78
Q-Air	Btu/h	1.46	0.73	-0.71	-1.43	-1.79
Q-Flanking	Btu/h	35.01	16.92	-17.20	-51.25	-70.66
Q -TAS	Btu/h	NA	NA	NA	NA	NA
Q- Final	Btu/h	-595.41	-284.97	238.30	442.02	536.13
RSI*	W·m ⁻² ·K ⁻¹	1.72	1.82	2.12	2.32	2.36
R-Value*	ft ² ·F·h·Btu ⁻¹	9.77	10.33	12.03	13.18	13.41

Wall 3: R-Value– Sealed and As-Built

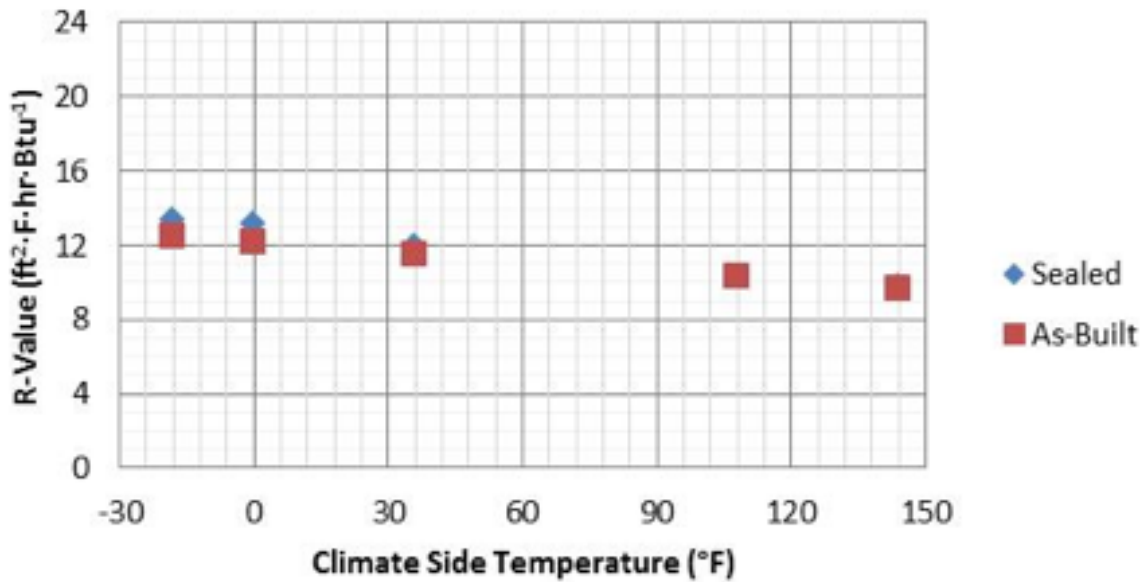

Wall 3: U-Value (Surface to Surface)

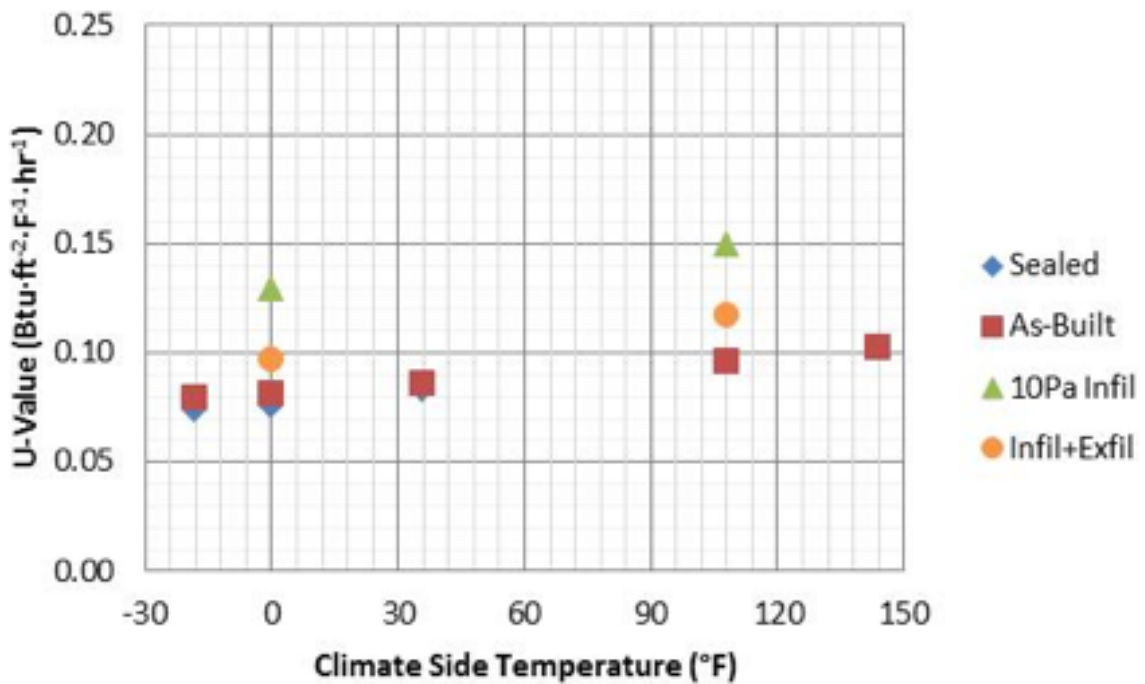

Wall 3: Building Energy Use per Wall

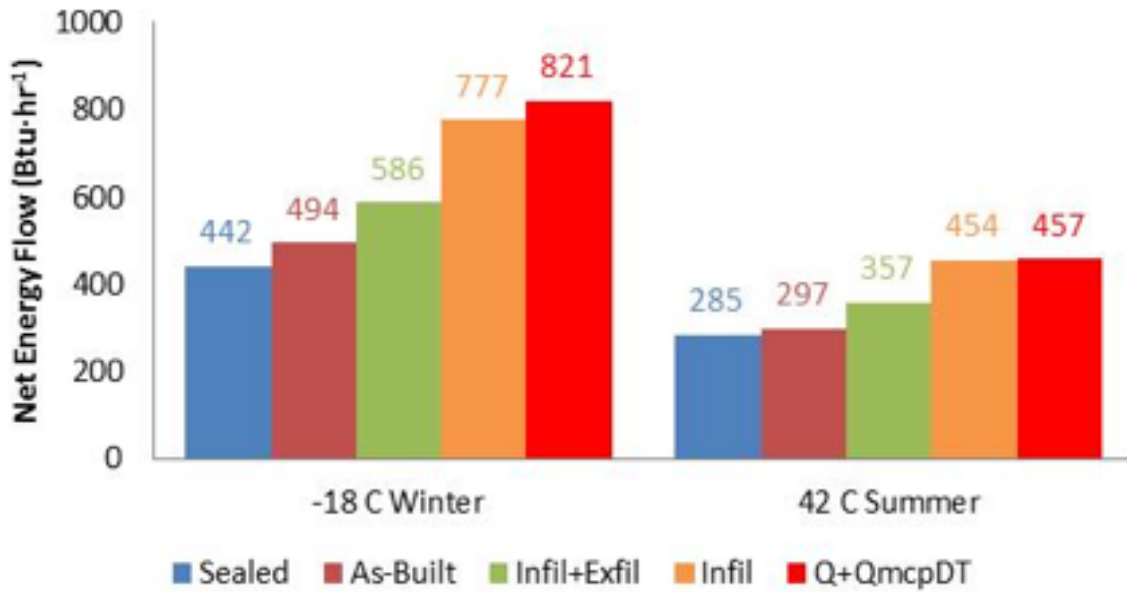

3.4 Reference Wall 4 – dsCFI

Wall Name:	Reference Wall 4 – damp-sprayed Cellulose Fiber Insulation	Build Date:	February, 2012
Reference Wall 4 comprises 2x4" S-P-F wood stud wall at 16" centers with 3.5" of damp-sprayed cellulose fiber insulation. The cellulose was dried to ambient conditions prior to testing. The wall was sheathed with 7/16" OSB sheathing.		Test Date:	February, 2012
		Researchers:	C. J. Schumacher A. P. Grin, P.Eng. R. T. Lepage, E.I.T.
Wall Dimensions	H: 2413mm (95.0"); L: 3635mm (143.125")		
Wall Area:	8.775m ² (94.42 sq.ft)		
Interior Finish	½" Drywall with 1/32" gap provided by machined shims		
Inside Air Seal	None		
Frame	2x4 S-P-F wood studs at 16" OC		
Electrical	Two outlets and one switch, with wiring		
Insulation	3.5" damp-sprayed cellulose fiber insulation		
Sheathing	7/16" OSB with 1/32" gap provided by machined shims		
Outside Air Seal	None		
WRB 1	Tyvek Housewrap		
Ext. Insulation	None		
WRB 2	None		
Drainspace	Integral in cladding		
Cladding	Vinyl Siding		
Framing Notes	2x4" S-P-F framing at 16" OC, double top plate, single bottom plate, and ½ width studs on edges		
Framing Factor	13.7%		

3.4.1 Material Properties

Material	Density		Moisture Content	Conductivity, k	R-Value / in.
	(kg/m ³)	(pcf)			
OSB Sheathing	599 ²		6-8% ²	0.0897 @ 23.9°C ³	1.61 @ 75°F ³
Spruce-Pine-Fir Framing	400 ¹		5-9% ²	0.0864 @ 23.9°C ³	1.67 @ 75°F ³
Damp-Sprayed Cellulose Fiber Insulation	57 ⁴	3.5 ⁴	30%RH	0.0381 @ 2°C ⁴ 0.0411 @ 23.9°C ⁴ 0.0422 @ 32°C ⁴	3.79 @ 35.6°F ⁴ 3.51 @ 75°F ⁴ 3.42 @ 89.6°F ⁴
Drywall	660 ²		-	0.146 @ 23.9°C ³	0.988 @ 75°F ³

- Notes:
- 1) Assumed from ASHRAE Handbook of Fundamentals 2009
 - 2) Measured at Building Science Labs; random sampling of material lots purchased for multiple wall specimens
 - 3) Measured at Building Science Labs (ASTM C518); random sampling of material lot; conductivity and R-value reported at mean temperature indicated
 - 4) Measured at Building Science Labs (ASTM C518); sampling of actual insulation materials from the test wall specimen; conductivity and R-value reported at mean temperature indicated

3.4.2 Schematics

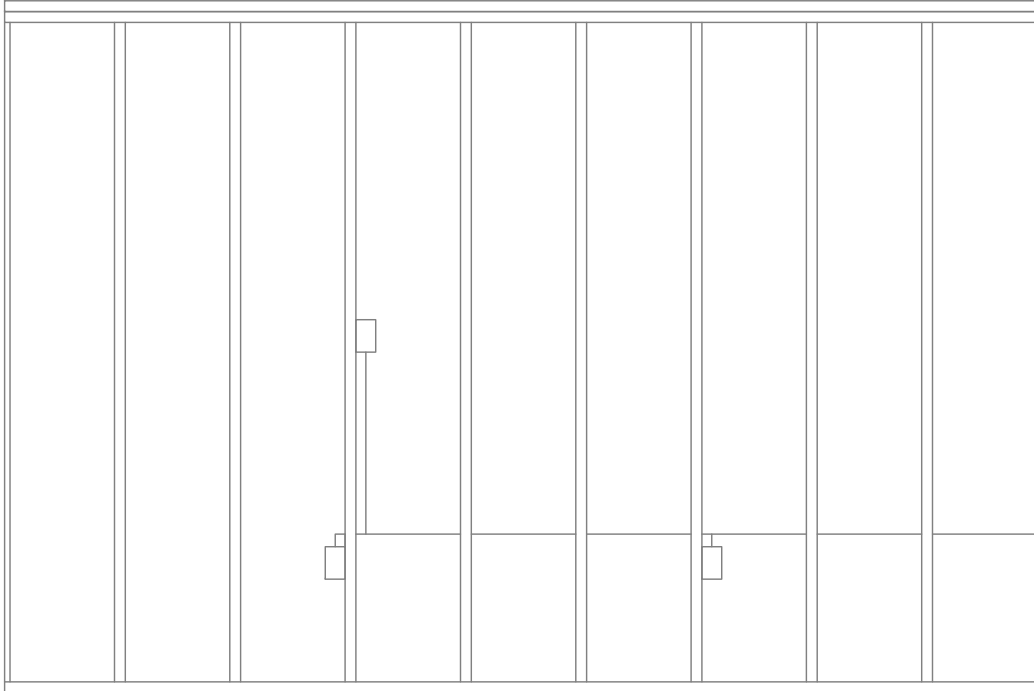

Figure 62 – Elevation of Framing & Electrical for Reference Wall 4 – 2x4 dsCFI

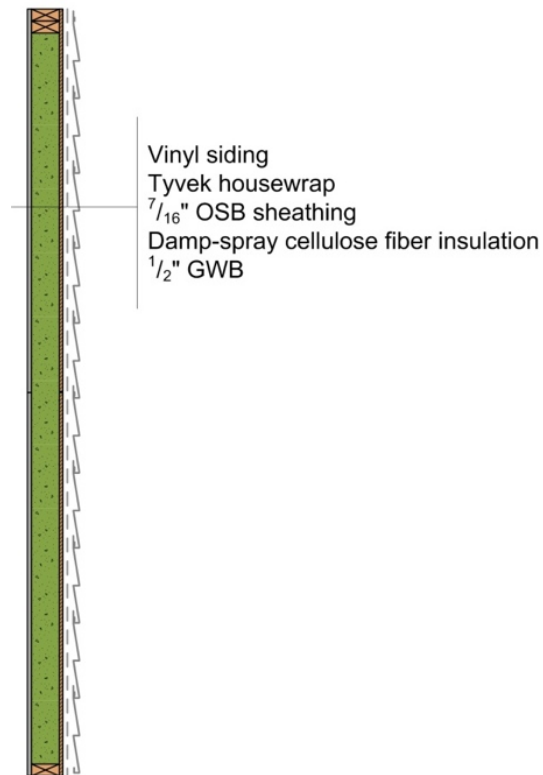

Figure 63 – Vertical Section for Reference Wall 4 – 2x4 dsCFI

3.4.3 Notes

Pre-Construction	<ul style="list-style-type: none"> BSCI staff pre-assembled the wall frame and sheathing prior to installation of the insulation.
Construction	<ul style="list-style-type: none"> Damp-spray cellulose was installed by an industry partner with expertise in the material and process. The test wall specimen was surrounded by a tent and heated on the OSB side to dry moisture out the open indoor side of the assembly. Dehumidifiers were used to remove moisture from the air in the tent. Sensors were used to measure the relative humidity of the wall assembly. Manual moisture content readings were made on a grid to ensure that the wall dried evenly. After approximately 10 days, the wall was dried to ambient room relative humidity (approximately 20-30% RH). The wall was installed in the hot box.
Testing	<ul style="list-style-type: none"> No comments
Decommissioning	<ul style="list-style-type: none"> Samples of the wall specimen were taken for thermal conductivity testing.
General	<ul style="list-style-type: none"> The reference wall performed as anticipated.

3.4.4 Photos



3.4.5 Test Results

Wall 4- 2x4 ds-CFI: Air Flow Testing

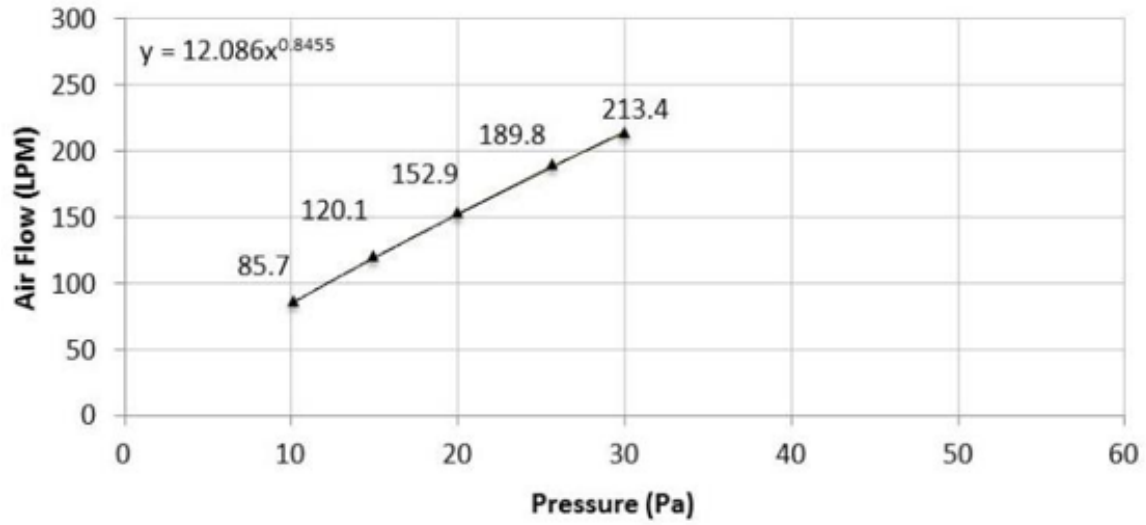

2015-06-18 – Thermal Metric Summary Report (June 2015 Update)

The results from the testing, at the specified temperature setpoints, are provided below. MB refers to the meter box; CB refers to the climate box.

Ref Wall 4 3.5" Damp-Spray CFI (as-built')		Test Regime (Interior Exterior Induced Airflow)					Induced Airflows (10Pa)			
	Units	22 62 none	22 42 none	22 2 none	22 -18 none	22 -28 none	22 -18 Inf	22 -18 Exf	22 42 Inf	22 42 Exf
Start Date	YY/MM/DD	12/03/13	12/02/25	12/02/10	12/02/14	12/02/21	12/02/15	12/02/19	12/03/03	12/03/09
End Date	YY/MM/DD	12/03/14	12/02/26	12/02/13	12/02/14	12/02/21	12/02/16	12/02/20	12/03/04	12/03/11
MB- Air Temp	C	22.04	21.97	21.66	21.37	21.28	21.27	21.47	22.01	21.96
CB- Air Temp	C	62.08	42.03	2.03	-17.97	-27.96	-17.97	-17.97	42.03	42.03
MB- Surf Temp	C	24.94	23.45	20.51	19.11	18.49	18.57	19.42	23.61	23.27
CB- Surf Temp	C	60.57	41.34	2.76	-16.37	-26.00	-16.57	-16.25	41.39	41.27
S-S Temp	C	35.63	17.89	-17.75	-35.48	-44.49	-35.14	-35.67	17.78	18.00
Q- Measured	W	-187.76	-92.37	83.02	163.85	201.39	223.95	141.28	-118.08	-84.13
Q-Air	W	4.02	1.23	-3.46	-10.50	-19.23	82.92	-99.50	-34.60	39.24
Q-Flanking	W	10.24	4.93	-5.06	-15.06	-20.74	-15.03	-15.10	4.92	4.93
Q -TAS	W	NA	NA	NA	NA	0.00	0.00	-3.17	-0.09	5.08
Q-Final	W	-177.52	-87.44	77.96	148.79	180.65	208.92	123.01	-113.17	-74.12
RSI*	W·m ² ·K ⁻¹	1.76	1.80	2.00	2.09	2.16	1.48	2.54	1.38	2.13
R-Value*	ft ² ·F·h·Btu ⁻¹	10.00	10.20	11.34	11.88	12.27	8.38	14.45	7.83	12.10

*Thermal resistance calculated by dividing the total corrected heat flow by the surface area of the sample and the surface temperature differentials between the meter box and the climate box.

Ref Wall 4 3.5" Damp-Spray CFI (Sealed 2 sides')		Test Regime (Interior Exterior Induced Airflow)				
	Units	22 62 none	22 42 none	22 2 none	22 -18 none	22 -28 none
Start Date	YY/MM/DD	12/04/03	12/03/31	12/03/17	12/03/20	12/03/21
End Date	YY/MM/DD	12/04/04	12/04/01	12/03/18	12/03/21	12/03/22
MB- Air Temp	C	22.06	21.96	21.69	21.44	21.37
CB- Air Temp	C	61.94	42.06	1.97	-17.96	-27.95
MB- Surf Temp	C	25.23	23.52	20.28	18.67	17.93
CB- Surf Temp	C	59.02	40.57	3.13	-15.33	-24.55
S-S Temp	C	33.78	17.05	-17.15	-34.00	-42.48
Q- Measured	W	-171.92	-81.11	78.40	150.65	185.46
Q-Air	W	0.45	0.14	-0.20	-0.42	-0.64
Q-Flanking	W	10.20	4.94	-5.08	-15.09	-20.78
Q -TAS	W	NA	NA	NA	NA	0.00
Q- Final	W	-161.72	-76.18	73.31	135.57	164.68
RSI*	W·m ² ·K ⁻¹	1.83	1.96	2.05	2.20	2.26
R-Value*	ft ² ·F·h·Btu ⁻¹	10.41	11.15	11.66	12.50	12.85

2015-06-18 – Thermal Metric Summary Report (June 2015 Update)

Ref Wall 4 3.5" Damp-Spray CFI (as-built)		Test Regime (Interior Exterior Induced Airflow)					Induced Airflows (10Pa)			
	Units	22 62 none	22 42 none	22 2 none	22 -18 none	22 -28 none	22 -18 Inf	22 -18 Exf	22 42 Inf	22 42 Exf
Start Date	YY/MM/DD	12/03/13	12/02/25	12/02/10	12/02/14	12/02/21	12/02/15	12/02/19	12/03/03	12/03/09
End Date	YY/MM/DD	12/03/14	12/02/26	12/02/13	12/02/14	12/02/21	12/02/16	12/02/20	12/03/04	12/03/11
MB- Air Temp	F	71.67	71.55	70.98	70.46	70.30	70.29	70.64	71.61	71.53
CB- Air Temp	F	143.74	107.65	35.65	-0.34	-18.32	-0.34	-0.34	107.65	107.65
MB- Surf Temp	F	77.26	74.40	68.36	65.19	63.76	64.25	65.90	74.68	74.16
CB- Surf Temp	F	141.02	106.41	36.98	2.53	-14.80	2.17	2.75	106.50	106.29
S-S Temp	F	63.76	32.01	-31.38	-62.66	-78.56	-62.08	-63.16	31.82	32.12
Q- Measured	Btu/h	-640.62	-315.15	283.25	559.03	687.12	764.08	482.03	-402.88	-287.04
Q-Air	Btu/h	13.68	4.18	-11.79	-35.77	-65.53	282.54	-339.07	-117.89	133.73
Q-Flanking	Btu/h	34.94	16.81	-17.27	-51.38	-70.77	-51.27	-51.51	16.78	16.81
Q -TAS	Btu/h	NA	NA	NA	NA	0.00	0.00	-10.82	-0.32	17.34
Q- Final	Btu/h	-605.67	-298.35	265.98	507.65	616.35	712.81	419.69	-386.10	-252.89
RSI*	W·m ⁻² ·K ⁻¹	1.76	1.80	2.00	2.09	2.16	1.48	2.54	1.38	2.13
R-Value*	ft ² ·F·h·Btu ⁻¹	10.00	10.20	11.34	11.88	12.27	8.38	14.45	7.83	12.10

*Thermal resistance calculated by dividing the total corrected heat flow by the surface area of the sample and the surface temperature differentials between the meter box and the climate box.

Ref Wall 4 3.5" Damp-Spray CFI (Sealed 2 sides)		Test Regime (Interior Exterior Induced Airflow)				
	Units	22 62 none	22 42 none	22 2 none	22 -18 none	22 -28 none
Start Date	YY/MM/DD	12/04/03	12/03/31	12/03/17	12/03/20	12/03/21
End Date	YY/MM/DD	12/04/04	12/04/01	12/03/18	12/03/21	12/03/22
MB- Air Temp	F	71.71	71.52	71.04	70.59	70.46
CB- Air Temp	F	143.50	107.71	35.54	-0.34	-18.31
MB- Surf Temp	F	77.90	74.59	68.11	64.81	63.28
CB- Surf Temp	F	138.23	105.03	37.63	4.40	-12.19
S-S Temp	F	60.33	30.44	-30.48	-60.40	-75.47
Q- Measured	Btu/h	-586.56	-276.75	267.48	514.00	632.74
Q-Air	Btu/h	1.52	0.46	-0.68	-1.43	-2.17
Q-Flanking	Btu/h	34.80	16.85	-17.35	-51.48	-70.89
Q -TAS	Btu/h	NA	NA	NA	NA	0.00
Q- Final	Btu/h	-551.76	-259.90	250.13	462.52	561.85
RSI*	W·m ⁻² ·K ⁻¹	1.83	1.96	2.05	2.20	2.26
R-Value*	ft ² ·F·h·Btu ⁻¹	10.41	11.15	11.66	12.50	12.85

Wall 4: R-Value– Sealed and As-Built

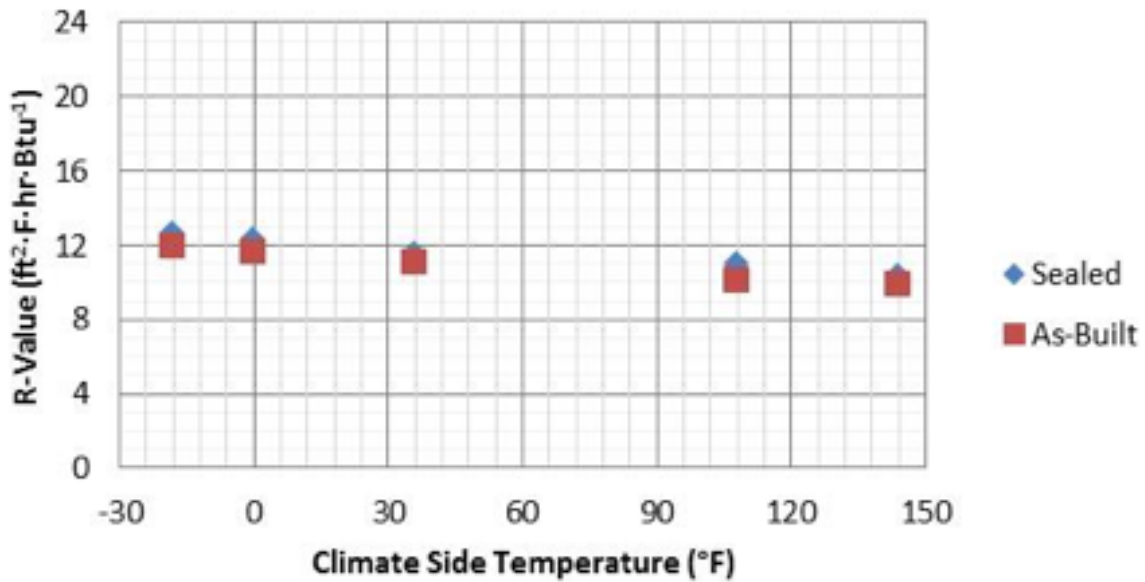

Wall 4: U-Value (Surface to Surface)

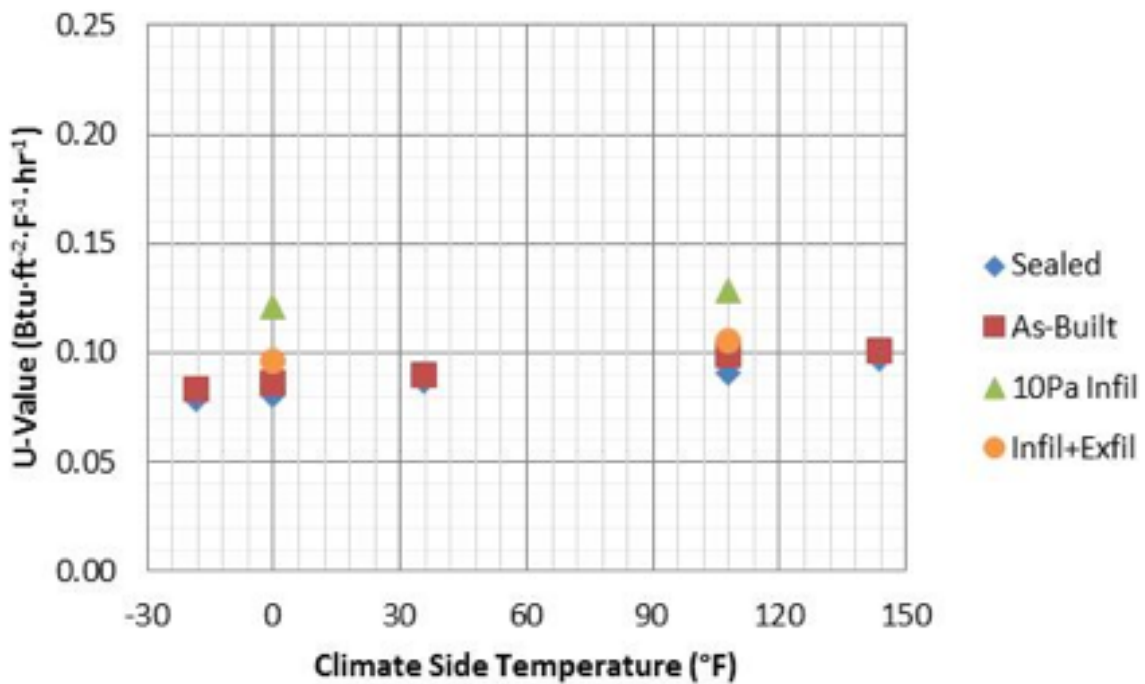

Wall 4: Building Energy Use per Wall

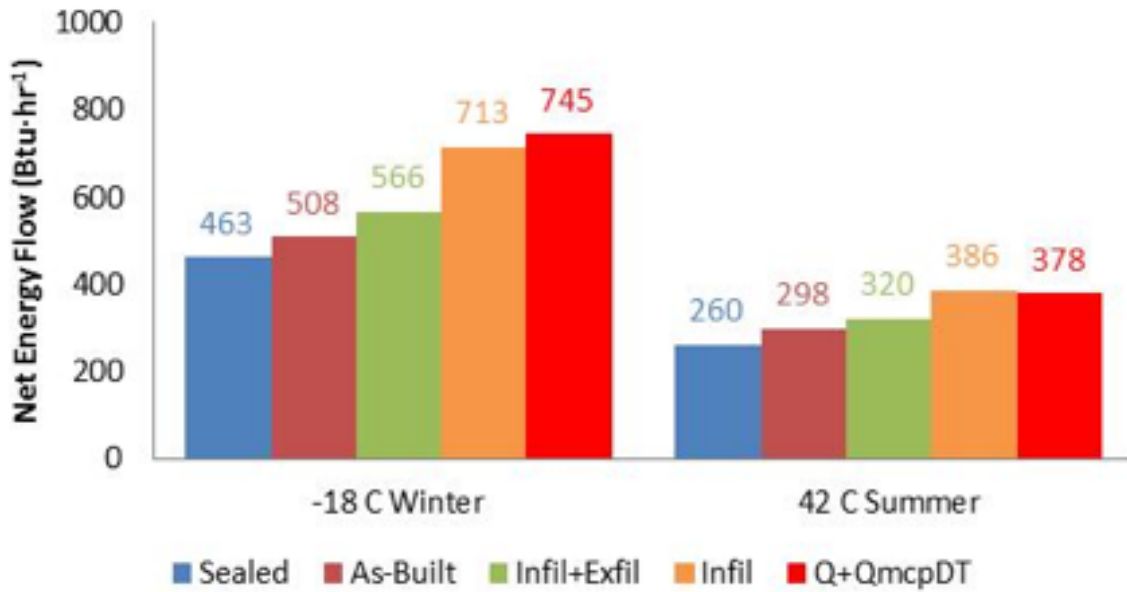

3.5 Reference Wall 5 – ocSPF

Reference Wall 5 is a 2x4 wall filled with 0.5 pcf open-cell spray polyurethane foam insulation (ocSPF). An ocSPF reference wall test specimen was prepared using the same approach as all of the other reference wall test specimens: insulation was installed by certified insulation contractor in accordance with the manufacturer’s instructions, and in the controlled climate conditions of the laboratory. Furthermore, the insulation was installed under the observation of an industry partner having expertise in ocSPF. However, the insulation install was found to have problems and ultimately it was deemed unacceptable. A second ocSPF reference wall test specimen was later prepared and accepted by an industry partner having expertise in ocSPF.

Both ocSPF wall assemblies were tested. This section of the report documents Reference Wall 5, the wall that was considered to have an **unacceptable** ocSPF install, and reference wall 5 II, the wall that was considered to have an **acceptable** ocSPF install.

Reference Wall 5 – ocSPF (*unacceptable* ocSPF insulation install)

Wall Name:	Reference Wall 5 – ocSPF	Build Date:	August, 2011
Reference Wall 5 comprises 2x4" S-P-F wood stud wall at 16" centers with a full bay depth lift of ocSPF insulation. The wall was sheathed with 7/16" OSB sheathing.		Test Date:	Aug. and Sept., 2011
		Researchers:	C. J. Schumacher A. P. Grin, P.Eng. R. T. Lepage, E.I.T.
Wall Dimensions	H: 2413mm (95.0"); L: 3635mm (143.125")		
Wall Area:	8.775m ² (94.42 sq.ft)		
Interior Finish	½" Drywall with 1/32" gap provided by machined shims		
Inside Air Seal	None		
Frame	2x4 S-P-F wood studs at 16" OC		
Electrical	Two outlets and one switch, with wiring		
Insulation	3.5" ocSPF		
Sheathing	7/16" OSB with 1/32" gap provided by machined shims		
Outside Air Seal	Integral in insulation system		
WRB 1	Tyvek Housewrap		
Ext. Insulation	None		
WRB 2	None		
Drainspace	Integral in cladding		
Cladding	Vinyl Siding		
Framing Notes	2x4" S-P-F framing at 16" OC, double top plate, single bottom plate, and ½ width studs on edges		
Framing Factor	13.7%		

3.5.1 Material Properties

Material	Density		Moisture Content	Conductivity, k	R-Value / in.
	(kg/m ³)	(pcf)			
OSB Sheathing	599 ²		6-8% ²	0.0897 @ 23.9°C ³	1.61 @ 75°F ³
Spruce-Pine-Fir Framing	400 ¹		5-9% ²	0.0864 @ 23.9°C ³	1.67 @ 75°F ³
3.5" ocSPF	8 ⁵	0.5 ⁵	-	0.0392 @ 2°C ⁴ 0.0443 @ 23.9°C ⁴ 0.0463 @ 32°C ⁴	3.68 @ 35.6°F ⁴ 3.25 @ 75°F ⁴ 3.12 @ 89.6°F ⁴
Drywall	660 ²		-	0.146 @ 23.9°C ³	0.988 @ 75°F ³

- Notes:
- 1) Assumed from ASHRAE Handbook of Fundamentals 2009
 - 2) Measured at Building Science Labs; random sampling of material lots purchased for multiple wall specimens
 - 3) Measured at Building Science Labs (ASTM C518); random sampling of material lot; conductivity & R-value reported at mean temperature indicated
 - 4) Measured at Building Science Labs (ASTM C518); sampling of actual insulation materials from the test wall specimen; conductivity & R-value reported at mean temperature indicated
 - 5) As advertised by manufacturer or calculated from advertised data

3.5.2 Schematics

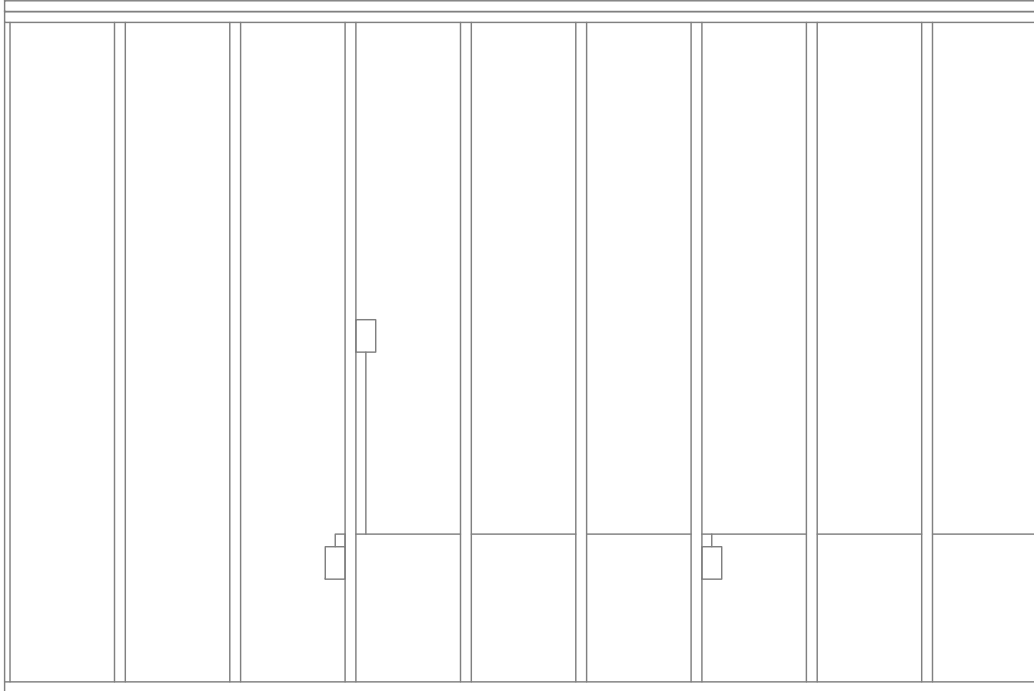

Figure 64: Elevation of Framing & Electrical for Reference Wall 5 – ocSPF

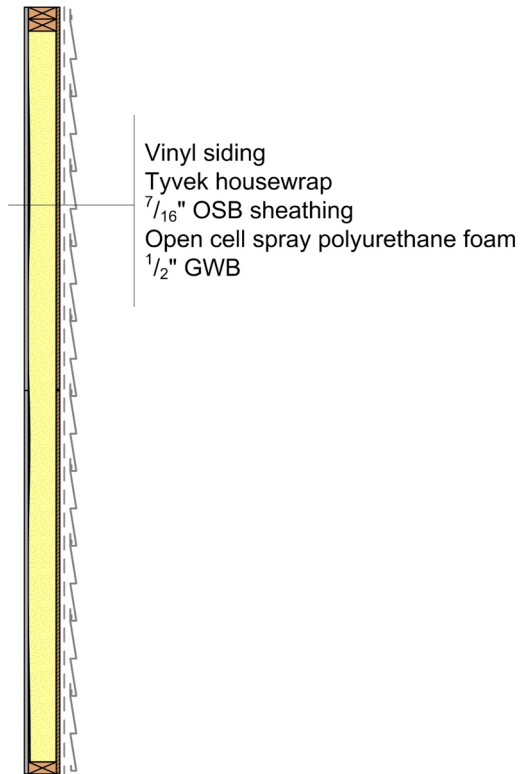

Figure 65: Vertical Section for Reference Wall 5 - ocSPF

3.5.3 Notes

Pre-Construction	<ul style="list-style-type: none"> BSCI staff pre-assembled the wall frame and sheathing prior to installation of the insulation.
Construction	<ul style="list-style-type: none"> An industry partner with expertise in ocSPF was on site to observe and instruct the installation of the 0.5pcf ocSPF insulation. This industry partner also provided the insulation components and selected the installer for the application of the insulation. BSCI staff noted that the foam was over scarfed (i.e. too much excess foam was removed) so that the average install depth (measured at 486 locations) was 80 mm (3.15 in.)
Testing	<ul style="list-style-type: none"> Material problems were identified early in testing. The problems were confirmed during decommissioning of the Ref Wall 5 test specimen. The installation of the ocSPF insulation was deemed unacceptable.
Decommissioning	<ul style="list-style-type: none"> Samples of the wall specimen were taken for thermal conductivity testing. During decommissioning the researchers confirmed there were areas where the foam did not adhere to the OSB sheathing. Large, connected voids developed between the foam and OSB sheathing during the install. BSCI staff cut the wall (lengthwise) into 6 pieces (each approximately 3.6 m or 12 ft. in length). The foam-to-OSB interface was measured at 233 locations along the cut lines. At 99 locations the foam was in direct contact with the wall. The average gap depth was 13.2 mm (0.52 in.) and the standard deviation was 7.2 mm (0.28 in.). The largest continuous gaps ran nearly the full height of the stud bay.
General	<ul style="list-style-type: none"> The reference wall did not perform as anticipated.

3.5.4 Photos



3.5.5 Test Results

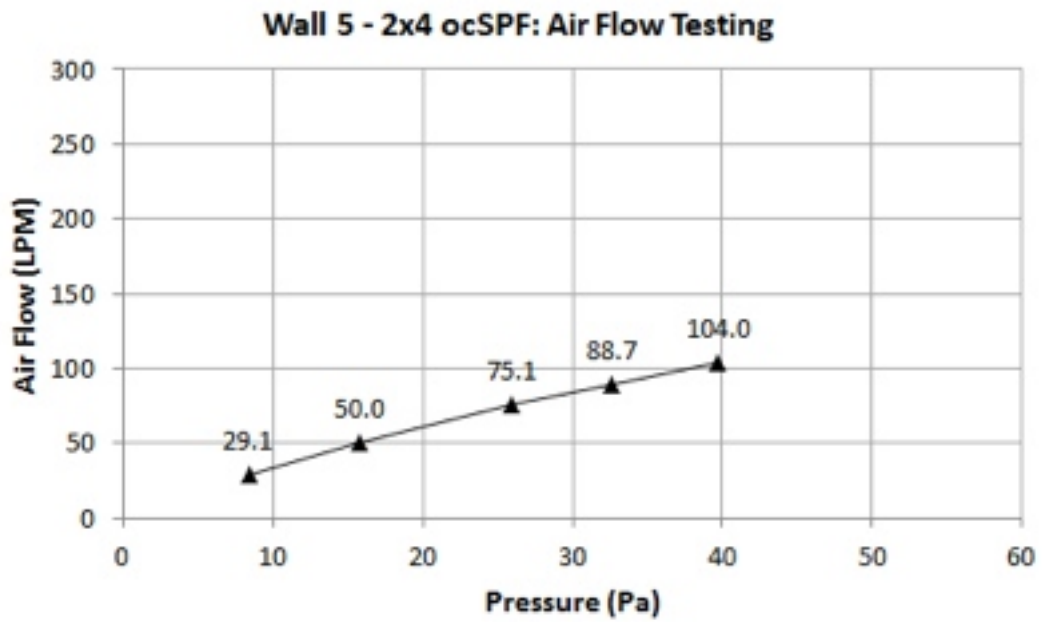

2015-06-18 – Thermal Metric Summary Report (June 2015 Update)

The results from the testing, at the specified temperature setpoints, are provided below. MB refers to the meter box; CB refers to the climate box.

Ref Wall 5 open-cell SPF (‘as-built’)		Test Regime (Interior Exterior Induced Air Flow)					Induced Air Flows (10Pa)			
	Units	22 62 none	22 42 none	22 2 none	22 -18 none	22 -28 none	22 -18 Inf	22 -18 Exf	22 42 Inf	22 42 Exf
Start Date	YY/MM/DD	11/09/24	11/09/13	11/08/17	11/08/22	11/08/27	11/08/25	11/08/26	11/09/17	11/09/22
End Date	YY/MM/DD	11/09/26	11/09/14	11/08/18	11/08/25	11/08/29	11/08/26	11/08/27	11/09/19	11/09/23
MB- Air Temp	C	22.02	21.53	21.48	21.23	21.15	21.21	21.24	21.69	21.94
CB- Air Temp	C	61.99	42.02	2.03	-17.96	-27.91	-17.97	-17.97	42.02	42.02
MB- Surf Temp	C	25.32	23.26	20.00	18.26	17.50	17.99	18.36	23.53	23.58
CB- Surf Temp	C	59.93	40.92	3.03	-15.88	-25.28	-15.97	-15.74	41.00	41.07
S-S Temp	C	34.61	17.66	-16.97	-34.14	-42.78	-33.96	-34.10	17.47	17.49
Q- Measured	W	-211.30	-98.10	88.20	170.10	207.60	189.00	162.30	-113.60	-95.60
Q-Air	W	2.80	1.37	-1.14	-3.36	-5.15	27.32	-38.11	-17.20	19.27
Q-Flanking	W	10.22	5.03	-5.02	-15.01	-20.67	-15.00	-15.01	4.99	4.93
Q -TAS	W	NA	NA	NA	NA	0.00	0.00	0.10	0.10	-0.20
Q-Final	W	-201.08	-93.07	83.18	155.09	186.93	174.00	147.39	-108.61	-90.87
RSI*	W·m ⁻² ·K ⁻¹	1.51	1.67	1.79	1.93	2.01	1.71	2.03	1.41	1.69
R-Value*	ft ² ·F·h·Btu ⁻¹	8.58	9.45	10.16	10.97	11.40	9.72	11.53	8.01	9.59

*Thermal resistance calculated by dividing the total corrected heat flow by the surface area of the sample and the surface temperature differentials between the meter box and the climate box.

Ref Wall 5 open-cell SPF (‘Sealed 2 sides’)		Test Regime (Interior Exterior Induced Air Flow)				
	Units	22 62 none	22 42 none	22 2 none	22 -18 none	22 -28 none
Start Date	YY/MM/DD	11/10/18	11/10/16	11/10/05	11/10/08	11/10/11
End Date	YY/MM/DD	11/10/19	11/10/17	11/10/07	11/10/11	11/10/12
MB- Air Temp	C	22.08	21.97	21.70	21.43	21.35
CB- Air Temp	C	62.08	42.02	1.99	-17.96	-27.97
MB- Surf Temp	C	26.25	24.03	19.97	18.16	17.34
CB- Surf Temp	C	59.24	40.92	3.35	-14.99	-23.39
S-S Temp	C	33.00	16.89	-16.62	-33.15	-40.73
Q- Measured	W	-187.70	-88.60	79.70	154.30	189.10
Q-Air	W	0.85	0.43	-0.42	-0.84	-1.06
Q-Flanking	W	10.23	4.92	-5.08	-15.08	-20.78
Q -TAS	W	NA	NA	NA	NA	0.00
Q- Final	W	-177.47	-83.68	74.62	139.22	168.32
RSI*	W·m ⁻² ·K ⁻¹	1.63	1.77	1.95	2.09	2.12
R-Value*	ft ² ·F·h·Btu ⁻¹	9.27	10.06	11.10	11.86	12.06

2015-06-18 – Thermal Metric Summary Report (June 2015 Update)

Ref Wall 5 open-cell SPF (‘as-built’)		Test Regime (Interior Exterior Induced Air Flow)					Induced Air Flows (10Pa)			
	Units	22 62 none	22 42 none	22 2 none	22 -18 none	22 -28 none	22 -18 Inf	22 -18 Exf	22 42 Inf	22 42 Exf
Start Date	YY/MM/DD	11/09/24	11/09/13	11/08/17	11/08/22	11/08/27	11/08/25	11/08/26	11/09/17	11/09/22
End Date	YY/MM/DD	11/09/26	11/09/14	11/08/18	11/08/25	11/08/29	11/08/26	11/08/27	11/09/19	11/09/23
MB- Air Temp	F	71.60	70.80	70.70	70.20	70.10	70.20	70.20	71.00	71.50
CB- Air Temp	F	143.60	107.60	35.60	-0.30	-18.20	-0.30	-0.30	107.60	107.60
MB- Surf Temp	F	77.60	73.90	68.00	64.90	63.50	64.40	65.00	74.40	74.50
CB- Surf Temp	F	139.90	105.70	37.50	3.40	-13.50	3.30	3.70	105.80	105.90
S-S Temp	F	62.30	31.80	-30.50	-61.50	-77.00	-61.10	-61.40	31.40	31.50
Q- Measured	Btu/h	-720.90	-334.50	300.90	580.20	708.40	644.90	553.60	-387.40	-326.10
Q-Air	Btu/h	9.61	4.67	-3.87	-11.49	-17.58	93.08	-129.98	-58.67	65.62
Q-Flanking	Btu/h	34.88	17.17	-17.12	-51.20	-70.52	-51.18	-51.22	17.04	16.83
Q -TAS	Btu/h	NA	NA	NA	NA	0.00	0.00	0.30	0.30	-0.60
Q- Final	Btu/h	-686.03	-317.53	283.80	529.15	637.77	593.65	502.85	-370.55	-310.03
RSI*	W·m ⁻² ·K ⁻¹	1.51	1.67	1.79	1.93	2.01	1.71	2.03	1.41	1.69
R-Value*	ft ² ·F·h·Btu ⁻¹	8.58	9.45	10.16	10.97	11.40	9.72	11.53	8.01	9.59

*Thermal resistance calculated by dividing the total corrected heat flow by the surface area of the sample and the surface temperature differentials between the meter box and the climate box.

Ref Wall 5 open-cell SPF (‘Sealed 2 sides’)		Test Regime (Interior Exterior Induced Air Flow)				
	Units	22 62 none	22 42 none	22 2 none	22 -18 none	22 -28 none
Start Date	YY/MM/DD	11/10/18	11/10/16	11/10/05	11/10/08	11/10/11
End Date	YY/MM/DD	11/10/19	11/10/17	11/10/07	11/10/11	11/10/12
MB- Air Temp	F	71.70	71.50	71.10	70.60	70.40
CB- Air Temp	F	143.70	107.60	35.60	-0.30	-18.30
MB- Surf Temp	F	79.20	75.30	68.00	64.70	63.20
CB- Surf Temp	F	138.60	105.70	38.00	5.00	-10.10
S-S Temp	F	59.40	30.40	-29.90	-59.70	-73.30
Q- Measured	Btu/h	-640.40	-302.30	271.90	526.60	645.20
Q-Air	Btu/h	2.98	1.49	-1.47	-2.94	-3.68
Q-Flanking	Btu/h	34.91	16.80	-17.34	-51.46	-70.89
Q -TAS	Btu/h	NA	NA	NA	NA	0.00
Q- Final	Btu/h	-605.49	-285.49	254.58	474.98	574.28
RSI*	W·m ⁻² ·K ⁻¹	1.63	1.77	1.95	2.09	2.12
R-Value*	ft ² ·F·h·Btu ⁻¹	9.27	10.06	11.10	11.86	12.06

Wall 5: R-Value - Sealed and As-Built

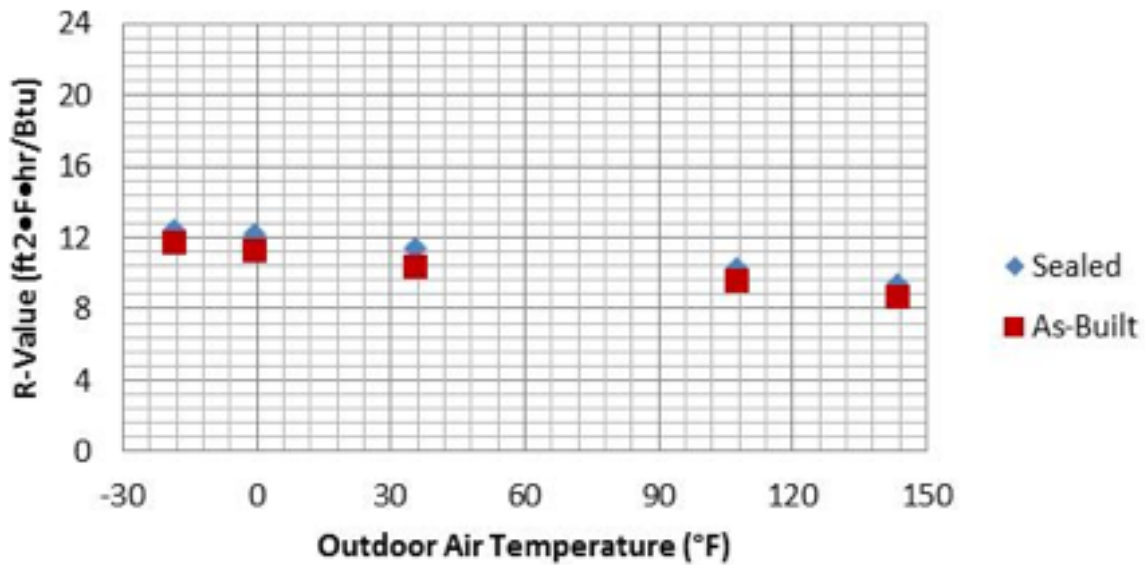

Wall 5: U-Value (Surface to Surface)

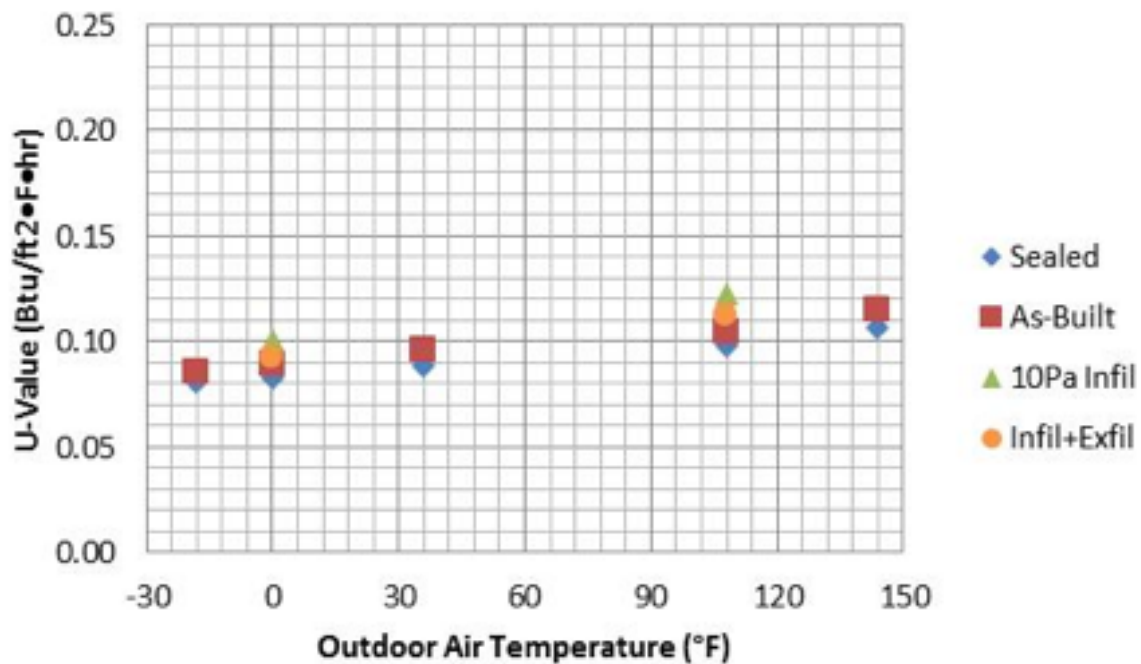

Wall 5: Building Energy Use per Wall

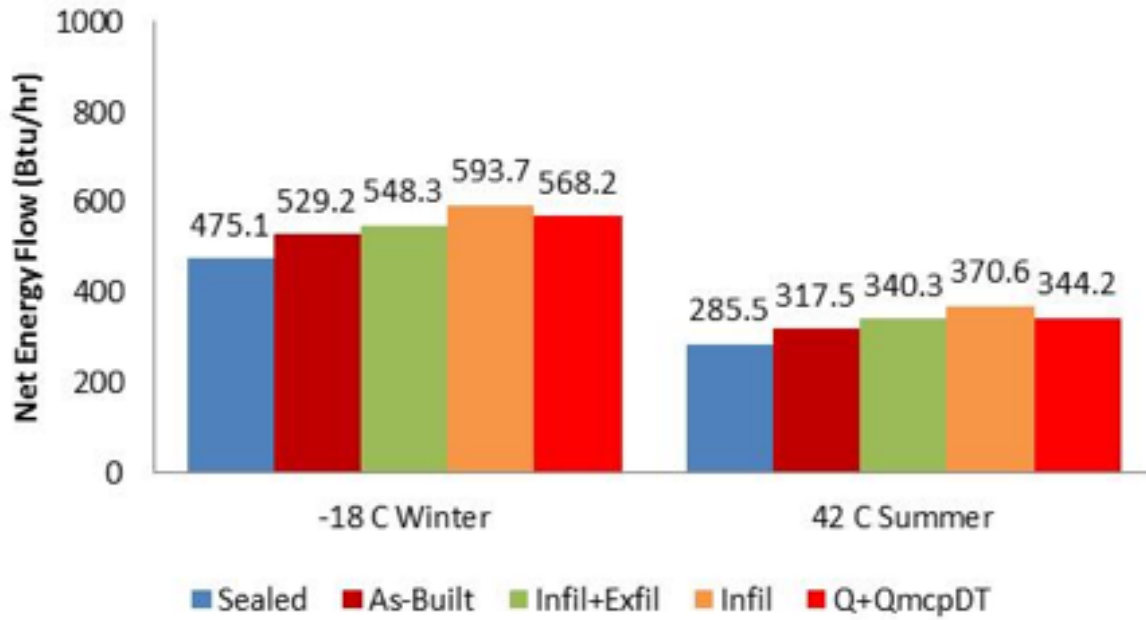

Reference Wall 5 II – ocSPF

Wall Name:	Reference Wall 5 II – ocSPF	Build Date:	November, 2014
Reference Wall 5 II comprises 2x4" S-P-F wood stud wall at 16" centers with a full bay depth lift of ocSPF insulation. The wall was sheathed with 7/16" OSB sheathing.		Test Date:	Nov. and Dec., 2014
		Researchers:	C. J. Schumacher A. P. Grin, P.Eng.
Wall Dimensions	H: 2413mm (95.0"); L: 3635mm (143.125")		
Wall Area:	8.775m ² (94.42 sq.ft)		
Interior Finish	½" Drywall with 1/32" gap provided by machined shims		
Inside Air Seal	None		
Frame	2x4 S-P-F wood studs at 16" OC		
Electrical	Two outlets and one switch, with wiring		
Insulation	3.5" ocSPF		
Sheathing	7/16" OSB with 1/32" gap provided by machined shims		
Outside Air Seal	Integral in insulation system		
WRB 1	Tyvek Housewrap		
Ext. Insulation	None		
WRB 2	None		
Drainspace	Integral in cladding		
Cladding	Vinyl Siding		
Framing Notes	2x4" S-P-F framing at 16" OC, double top plate, single bottom plate, and ½ width studs on edges		
Framing Factor	13.7%		

3.5.6 Material Properties

Material	Density		Moisture Content	Conductivity, k	R-Value / in.
	(kg/m ³)	(pcf)			
OSB Sheathing	599 ²		6-8% ²	0.0897 @ 23.9°C ³	1.61 @ 75°F ³
Spruce-Pine-Fir Framing	400 ¹		5-9% ²	0.0864 @ 23.9°C ³	1.67 @ 75°F ³
3.5" ocSPF II	8 ⁵	0.5 ⁵	-	0.0356 @ 2°C ⁴ 0.0391 @ 23.9°C ⁴ 0.0424 @ 42°C ⁴	4.1 @ 35.6°F ⁴ 3.7 @ 75°F ⁴ 3.4 @ 108°F ⁴
Drywall	660 ²		-	0.146 @ 23.9°C ³	0.988 @ 75°F ³

- Notes:
- 1) Assumed from ASHRAE Handbook of Fundamentals 2009
 - 2) Measured at Building Science Labs; random sampling of material lots purchased for multiple wall specimens
 - 3) Measured at Building Science Labs (ASTM C518); random sampling of material lot; conductivity & R-value reported at mean temperature indicated
 - 4) Measured at Building Science Labs (ASTM C518); sampling of actual insulation materials from the test wall specimen; conductivity & R-value reported at mean temperature indicated
 - 5) As advertised by manufacturer or calculated from advertised data

3.5.7 Schematics

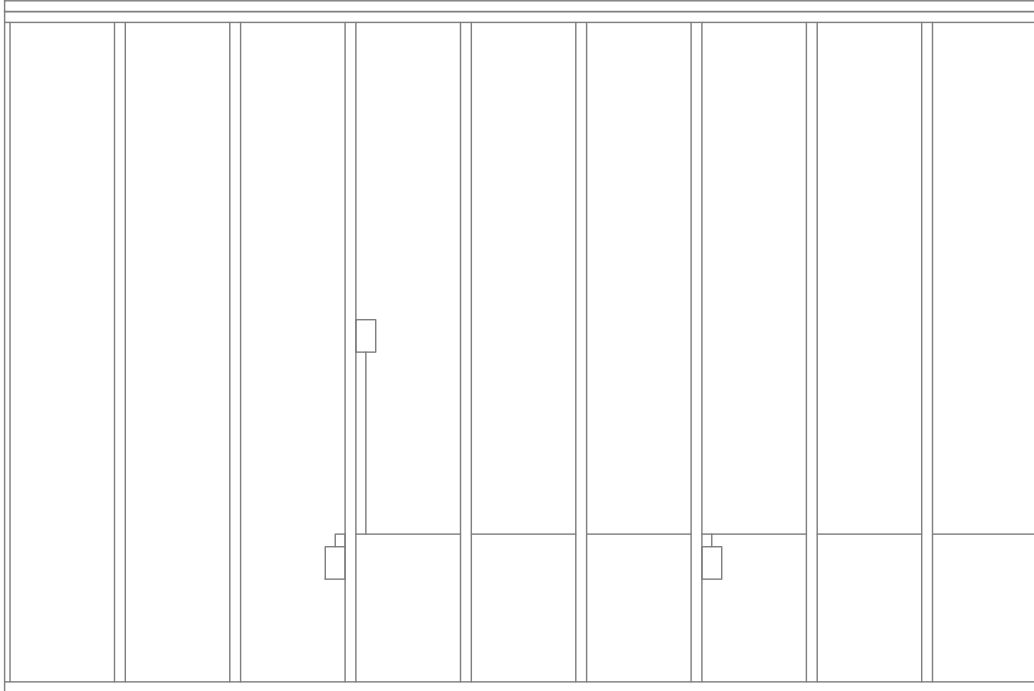

Figure 66: Elevation of Framing & Electrical for Reference Wall 5 II – ocSPF

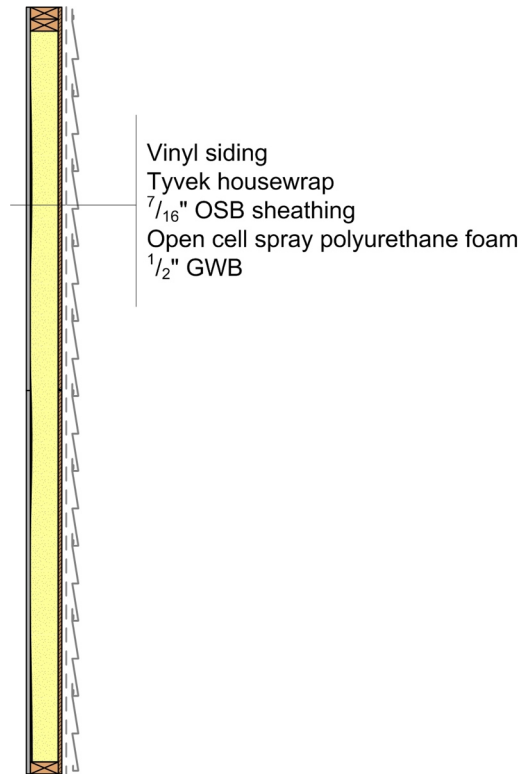

Figure 67: Vertical Section for Reference Wall 5 II - ocSPF

3.5.8 Notes

Pre-Construction	<ul style="list-style-type: none"> BSCI staff pre-assembled the wall frame and sheathing prior to installation of the insulation.
Construction	<ul style="list-style-type: none"> An industry partner with expertise in ocSPF was on site to observe and instruct the installation of the 0.5pcf ocSPF insulation. This industry partner also provided the insulation components and selected the installer for the application of the insulation.
Testing	<ul style="list-style-type: none"> Nothing unexpected was noted.
Decommissioning	<ul style="list-style-type: none"> Samples of the wall specimen were taken for thermal conductivity testing. Upon decommissioning the wall, BSCI staff cut up the wall section. Small areas were found that contained discrete voids or poor adhesion between the ocSPF and the OSB sheathing. The ocSPF appeared to develop a better bond to the framing than the OSB sheathing. In all 9 stud bays the foam was well adhered to the studs, top, and bottom plates.
General	<ul style="list-style-type: none"> The reference wall performed as anticipated.

3.5.9 Photos



3.5.10 Test Results

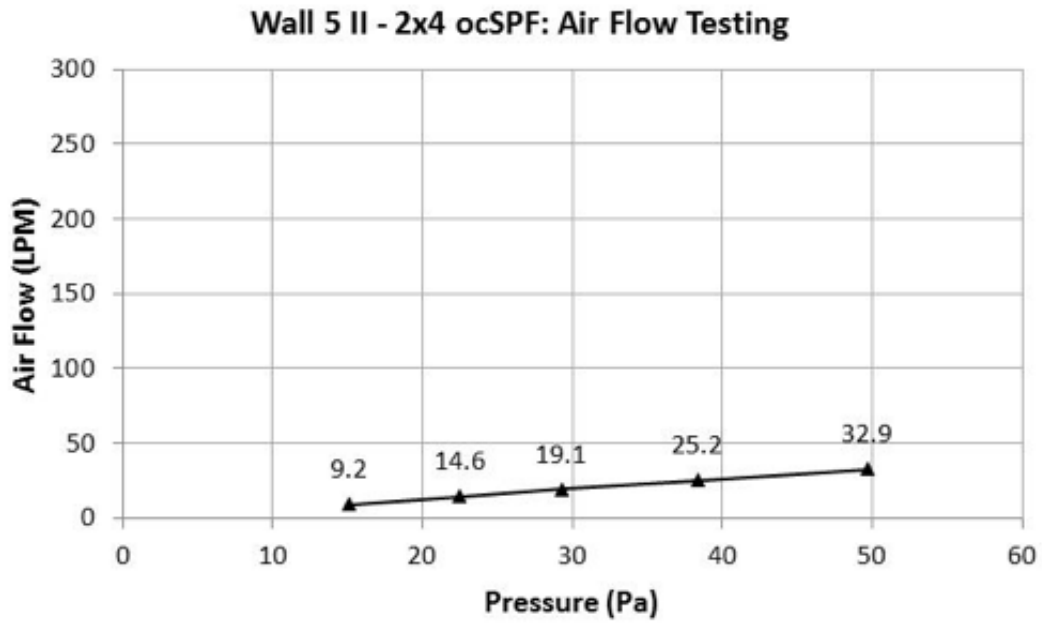

2015-06-18 – Thermal Metric Summary Report (June 2015 Update)

The results from the testing, at the specified temperature setpoints, are provided below. MB refers to the meter box; CB refers to the climate box.

Ref Wall 5 II open-cell SPF (‘as-built’)		Test Regime (Interior Exterior Induced Air Flow)					Induced Air Flows (10Pa)			
	Units	22 62 none	22 42 none	22 2 none	22 -18 none	22 -28 none	22 -18 Inf	22 -18 Exf	22 42 Inf	22 42 Exf
Start Date	YY/MM/DD	14/11/29	14/11/16	14/10/29	14/10/31	14/11/10	14/11/04	14/11/06	14/11/19	14/11/26
End Date	YY/MM/DD	14/12/01	14/11/17	14/10/31	14/11/02	14/11/12	14/11/06	14/11/09	14/11/23	14/11/28
MB- Air Temp	C	21.85	21.65	21.38	21.06	20.94	21.03	21.06	21.73	21.70
CB- Air Temp	C	62.00	42.00	2.00	-18.00	-28.00	-18.00	-18.00	42.00	42.00
MB- Surf Temp	C	24.98	22.99	19.78	18.13	17.37	18.05	18.11	23.22	23.15
CB- Surf Temp	C	60.51	40.69	2.42	-16.85	-26.31	-16.84	-16.85	41.24	41.22
S-S Temp	C	35.53	17.70	-17.36	-34.98	-43.68	-34.90	-34.96	18.02	18.07
Q- Measured	W	-188.25	-94.00	80.43	158.65	190.91	162.16	155.47	-100.86	-84.01
Q-Air	W	2.18	0.87	-0.85	-1.69	-1.96	-7.38	-8.44	5.96	11.24
Q-Flanking	W	10.27	5.00	-4.99	-14.96	-20.62	-14.94	-14.96	4.98	4.99
Q -TAS	W	NA	NA	NA	NA	0.00	0.00	0.08	0.06	-2.29
Q-Final	W	-177.98	-89.00	75.43	143.69	170.30	147.21	140.60	-95.89	-81.32
RSI*	W·m ⁻² ·K ⁻¹	1.75	1.74	2.02	2.14	2.25	2.08	2.18	1.65	1.95
R-Value*	ft ² ·F·h·Btu ⁻¹	9.95	9.91	11.47	12.13	12.78	11.81	12.39	9.36	11.07

*Thermal resistance calculated by dividing the total corrected heat flow by the surface area of the sample and the surface temperature differentials between the meter box and the climate box.

Ref Wall 5 II open-cell SPF (‘Sealed 2 sides’)		Test Regime (Interior Exterior Induced Air Flow)				
	Units	22 62 none	22 42 none	22 2 none	22 -18 none	22 -28 none
Start Date	YY/MM/DD	14/12/18	14/12/16	14/12/05	14/12/09	14/12/13
End Date	YY/MM/DD	14/12/21	14/12/17	14/12/08	14/12/11	14/12/15
MB- Air Temp	C	21.87	21.75	21.45	21.11	21.02
CB- Air Temp	C	62.00	42.07	2.00	-18.07	-28.00
MB- Surf Temp	C	25.39	23.28	19.80	17.97	17.22
CB- Surf Temp	C	59.63	40.57	2.96	-15.75	-24.44
S-S Temp	C	34.24	17.28	-16.84	-33.73	-41.66
Q- Measured	W	-176.02	-86.35	75.30	143.83	174.42
Q-Air	W	0.00	0.00	-0.47	0.00	0.00
Q-Flanking	W	10.27	4.99	-5.02	-15.00	-20.65
Q -TAS	W	NA	NA	NA	NA	0.00
Q- Final	W	-165.76	-81.35	70.29	128.82	153.77
RSI*	W·m ⁻² ·K ⁻¹	1.81	1.86	2.10	2.30	2.38
R-Value*	ft ² ·F·h·Btu ⁻¹	10.29	10.59	11.94	13.04	13.50

2015-06-18 – Thermal Metric Summary Report (June 2015 Update)

Ref Wall 5 II open-cell SPF (‘as-built’)		Test Regime (Interior Exterior Induced Air Flow)					Induced Air Flows (10Pa)			
	Units	22 62 none	22 42 none	22 2 none	22 -18 none	22 -28 none	22 -18 Inf	22 -18 Exf	22 42 Inf	22 42 Exf
Start Date	YY/MM/DD	14/11/29	14/11/16	14/10/29	14/10/31	14/11/10	14/11/04	14/11/06	14/11/19	14/11/26
End Date	YY/MM/DD	14/12/01	14/11/17	14/10/31	14/11/02	14/11/12	14/11/06	14/11/09	14/11/23	14/11/28
MB- Air Temp	F	71.34	70.97	70.48	69.91	69.69	69.85	69.92	71.11	71.06
CB- Air Temp	F	143.60	107.60	35.60	-0.40	-18.40	-0.40	-0.40	107.60	107.60
MB- Surf Temp	F	76.96	73.39	67.60	64.63	63.27	64.49	64.60	73.79	73.67
CB- Surf Temp	F	140.91	105.24	36.35	1.67	-15.35	1.68	1.68	106.23	106.20
S-S Temp	F	63.95	31.85	-31.25	-62.96	-78.63	-62.81	-62.93	32.43	32.52
Q- Measured	Btu/h	-642.28	-320.71	274.41	541.28	651.36	553.25	530.45	-344.13	-286.64
Q-Air	Btu/h	7.44	2.96	-2.89	-5.77	-6.66	-25.14	-28.75	20.31	38.30
Q-Flanking	Btu/h	35.04	17.05	-17.04	-51.03	-70.34	-50.99	-51.03	16.99	17.01
Q -TAS	Btu/h	NA	NA	NA	NA	0.00	0.00	0.27	0.20	-7.80
Q- Final	Btu/h	-607.25	-303.66	257.36	490.25	581.02	502.26	479.69	-327.14	-277.43
RSI*	W·m ⁻² ·K ⁻¹	1.75	1.74	2.02	2.14	2.25	2.08	2.18	1.65	1.95
R-Value*	ft ² ·F·h·Btu ⁻¹	9.95	9.91	11.47	12.13	12.78	11.81	12.39	9.36	11.07

*Thermal resistance calculated by dividing the total corrected heat flow by the surface area of the sample and the surface temperature differentials between the meter box and the climate box.

Ref Wall 5 II open-cell SPF (‘Sealed 2 sides’)		Test Regime (Interior Exterior Induced Air Flow)				
	Units	22 62 none	22 42 none	22 2 none	22 -18 none	22 -28 none
Start Date	YY/MM/DD	14/12/18	14/12/16	14/12/05	14/12/09	14/12/13
End Date	YY/MM/DD	14/12/21	14/12/17	14/12/08	14/12/11	14/12/15
MB- Air Temp	F	71.36	71.14	70.62	70.00	69.84
CB- Air Temp	F	143.60	107.73	35.60	-0.53	-18.40
MB- Surf Temp	F	77.71	73.91	67.63	64.35	63.00
CB- Surf Temp	F	139.33	105.02	37.33	3.65	-11.99
S-S Temp	F	61.63	31.11	-30.31	-60.71	-75.00
Q- Measured	Btu/h	-600.55	-294.60	256.92	490.71	595.09
Q-Air	Btu/h	0.00	0.00	-1.60	0.00	0.00
Q-Flanking	Btu/h	35.03	17.03	-17.11	-51.19	-70.46
Q -TAS	Btu/h	NA	NA	NA	NA	0.00
Q- Final	Btu/h	-565.53	-277.57	239.81	439.52	524.63
RSI*	W·m ⁻² ·K ⁻¹	1.81	1.86	2.10	2.30	2.38
R-Value*	ft ² ·F·h·Btu ⁻¹	10.29	10.59	11.94	13.04	13.50

Wall 5 II: R-Value - Sealed and As-Built

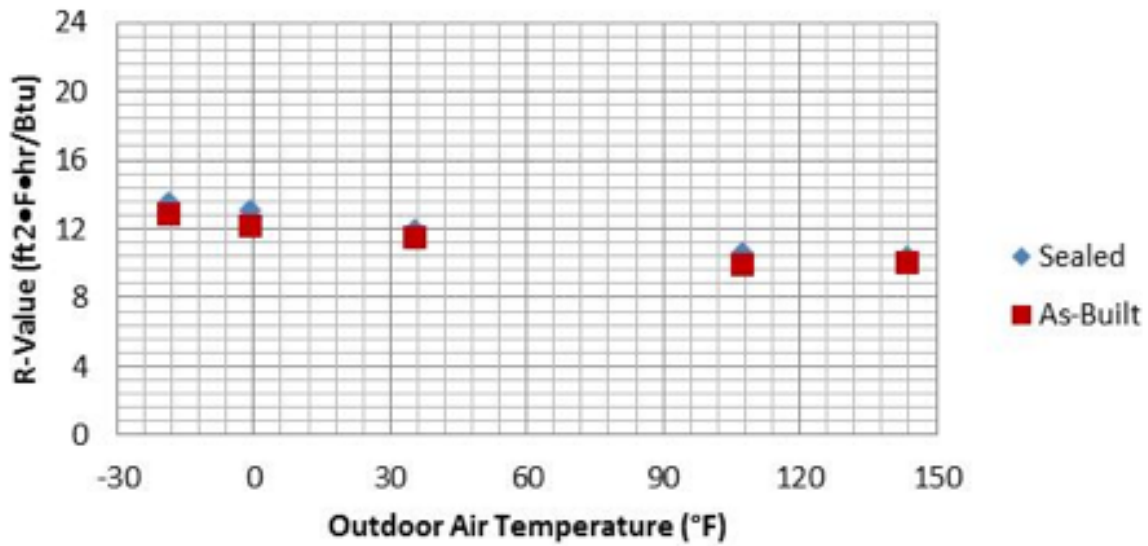

Wall 5 II: U-Value (Surface to Surface)

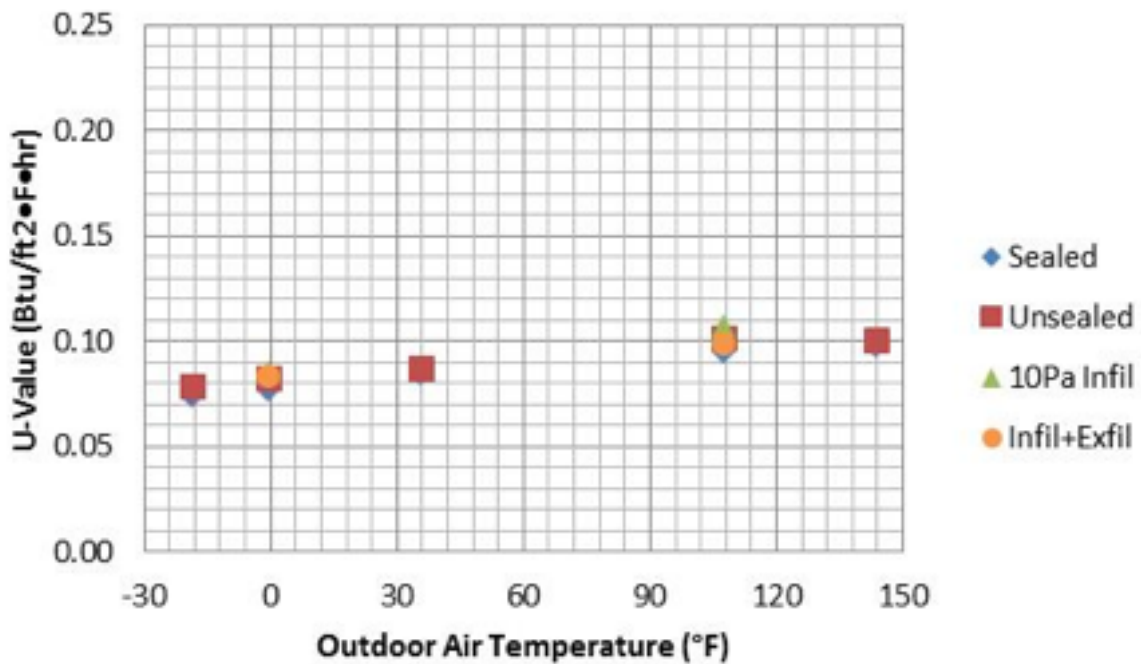

Wall 5 II: Building Energy Use per Wall

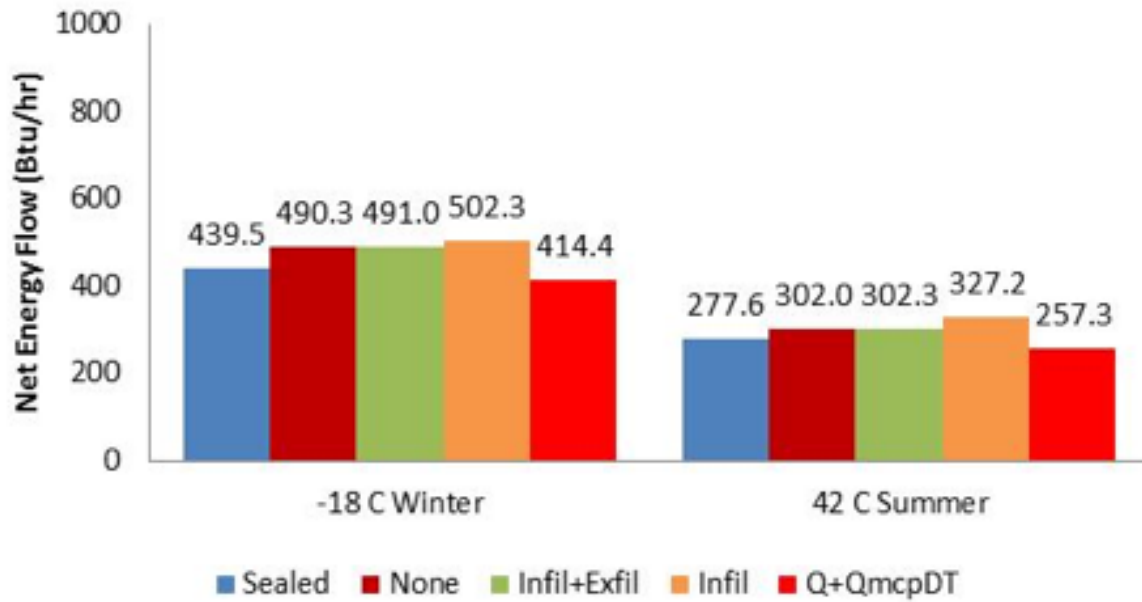

3.6 Reference Wall 6 – ccSPF

Wall Name:	Reference Wall 6 – ccSPF	Build Date:	October, 2010
Reference Wall 6 comprises 2x4" S-P-F wood stud wall at 16" centers with a single 2" lift of ccSPF insulation. The wall was aged in excess of 180 days. The wall was sheathed with 7/16" OSB sheathing.		Test Date:	October, 2011
		Researchers:	C. J. Schumacher A. P. Grin, P.Eng. R. T. Lepage, E.I.T.
Wall Dimensions	H: 2413mm (95.0"); L: 3635mm (143.125")		
Wall Area:	8.775m ² (94.42 sq.ft)		
Interior Finish	½" Drywall with 1/32" gap provided by machined shims		
Inside Air Seal	None		
Frame	2x4 S-P-F wood studs at 16" OC		
Electrical	Two outlets and one switch, with wiring		
Insulation	2" ccSPF (actually installed was 53 mm or 2.09")		
Sheathing	7/16" OSB with 1/32" gap provided by machined shims		
Outside Air Seal	Integral in insulation system		
WRB 1	Tyvek Housewrap		
Ext. Insulation	None		
WRB 2	None		
Drainspace	Integral in cladding		
Cladding	Vinyl Siding		
Framing Notes	2x4" S-P-F framing at 16" OC, double top plate, single bottom plate, and ½ width studs on edges		
Framing Factor	13.7%		

3.6.1 Material Properties

Material	Density		Moisture Content	Conductivity, k	R-Value / in.
	(kg/m ³)	(pcf)			
OSB Sheathing	599 ²		6-8% ²	0.0897 @ 23.9°C ³	1.61 @ 75°F ³
Spruce-Pine-Fir Framing	400 ¹		5-9% ²	0.0864 @ 23.9°C ³	1.67 @ 75°F ³
2" 2pcf ccSPF	39 ⁴	2.4 ⁴	-	0.0238 @ 2°C ⁴ 0.0262 @ 23.9°C ⁴ 0.0271 @ 32°C ⁴	6.06 @ 35.6°F ⁴ 5.50 @ 75°F ⁴ 5.32 @ 89.6°F ⁴
Drywall	660 ²		-	0.146 @ 23.9°C ³	0.988 @ 75°F ³

- Notes:
- 1) Assumed from ASHRAE Handbook of Fundamentals 2009
 - 2) Measured at Building Science Labs; random sampling of material lots purchased for multiple wall specimens
 - 3) Measured at Building Science Labs (ASTM C518); random sampling of material lot; conductivity and R-value reported at mean temperature indicated
 - 4) Measured at Building Science Labs (ASTM C518); sampling of actual insulation materials from the test wall specimen; conductivity and R-value reported at mean temperature indicated

3.6.2 Schematics

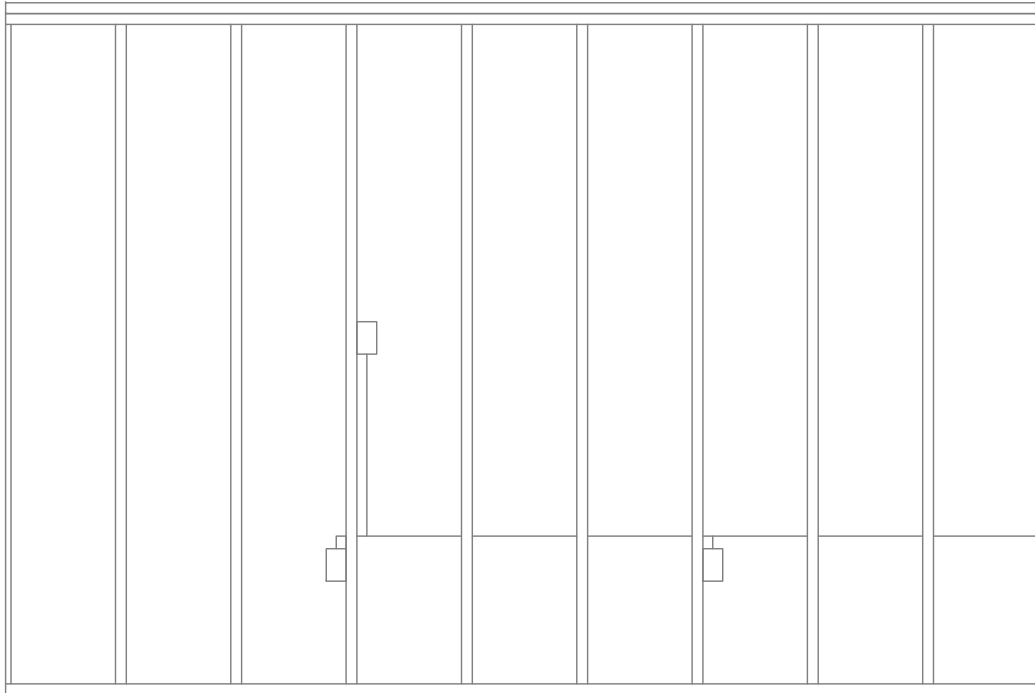

Figure 68 – Elevation of Framing & Electrical for Reference Wall 6 – ccSPF

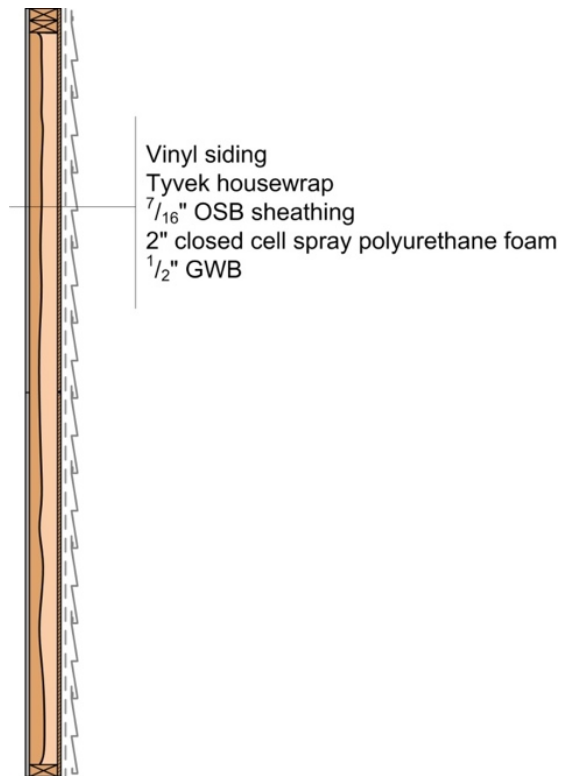
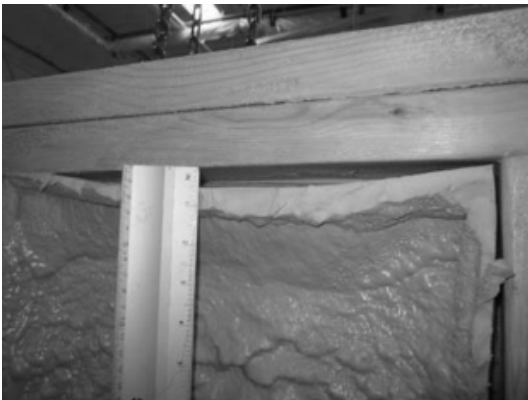
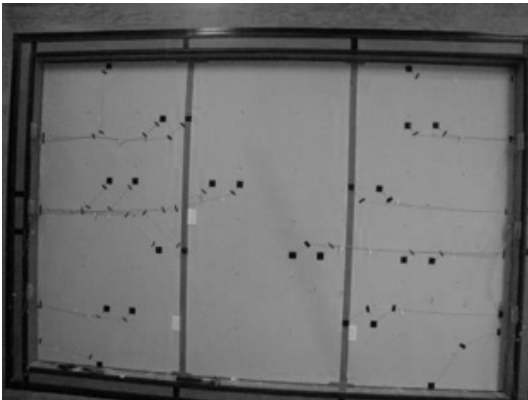

Figure 69 – Vertical Section for Reference Wall 6 - ccSPF

3.6.3 Notes

Pre-Construction	<ul style="list-style-type: none"> BSCI staff pre-assembled the wall frame and sheathing prior to installation of the insulation.
Construction	<ul style="list-style-type: none"> An industry partner with expertise in ccSPF was on site to observe and instruct the installation of the 2pcf ccSPF insulation. This industry partner also provided the insulation components and selected the installer for the application of the insulation. The wall was aged more than 180 days prior to testing. At the end of the aging, and before installation of the gypsum wall board and siding for testing, BSCI staff noted that the ccSPF had pulled away from the top plate in two bays. BSCI contacted the industry partner having expertise. BSCI was instructed to proceed with the testing.
Testing	<ul style="list-style-type: none"> No comments
Decommissioning	<ul style="list-style-type: none"> Samples of the wall specimen were taken for thermal conductivity testing. Upon decommissioning the wall, BSCI staff cut up the wall section and, in the area where the ccSPF had pulled away from the top plate, discovered that the ccSPF was fully adhered at the stud to the sheathing joint.
General	<ul style="list-style-type: none"> The reference wall performed as anticipated.

3.6.4 Photos



3.6.5 Test Results

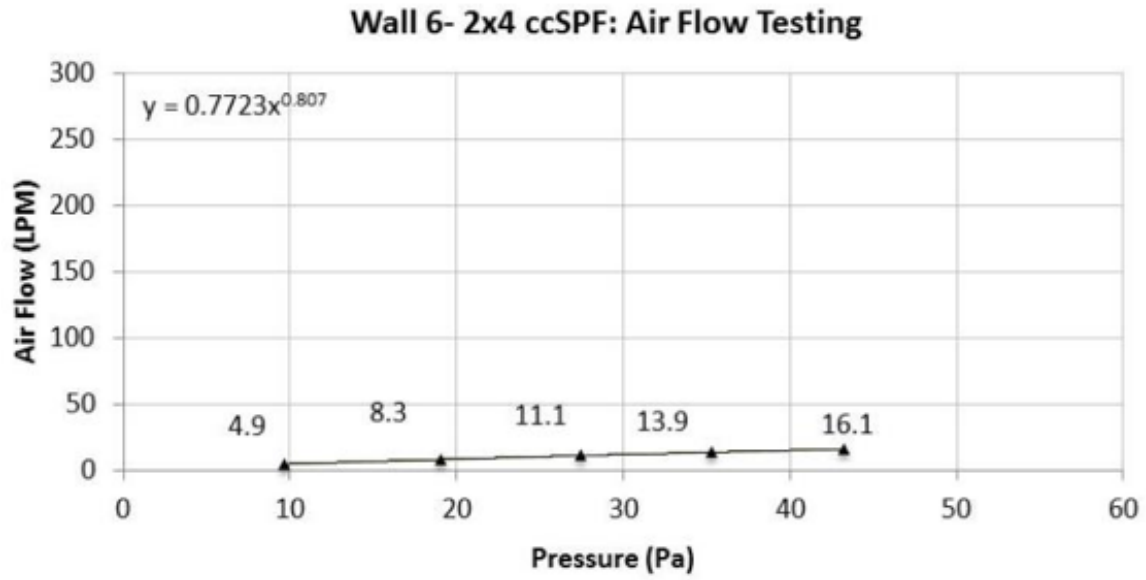

2015-06-18 – Thermal Metric Summary Report (June 2015 Update)

The results from the testing, at the specified temperature setpoints, are provided below. MB refers to the meter box; CB refers to the climate box.

Ref Wall 6 2" Closed-cell SPF (as-built)		Test Regime (Interior Exterior Induced Airflow)					Induced Airflows (10Pa)			
	Units	22 62 none	22 42 none	22 2 none	22 -18 none	22 -28 none	22 -18 Inf	22 -18 Exf	22 42 Inf	22 42 Exf
Start Date	YY/MM/DD	11/12/01	11/11/18	11/10/29	11/11/04	11/11/15	11/11/09	11/11/12	11/11/22	11/11/25
End Date	YY/MM/DD	11/12/05	11/11/21	11/11/02	11/11/07	11/11/17	11/11/11	11/11/14	11/11/24	11/11/30
MB- Air Temp	C	22.01	21.91	21.70	21.42	21.32	21.34	21.41	21.94	21.92
CB- Air Temp	C	62.08	42.06	2.03	-17.96	-27.89	-17.97	-17.97	42.04	42.04
MB- Surf Temp	C	24.66	23.28	20.75	19.57	19.02	19.13	19.66	23.34	23.28
CB- Surf Temp	C	60.60	41.39	2.71	-16.49	-26.03	-16.57	-16.47	41.00	41.36
S-S Temp	C	35.94	18.11	-18.04	-36.06	-45.05	-35.70	-36.13	17.66	18.09
Q- Measured	W	-183.31	-87.42	79.87	157.24	193.30	201.94	152.55	-103.94	-87.11
Q-Air	W	0.63	0.30	-1.08	-3.50	-6.08	47.20	-50.80	-11.96	13.32
Q-Flanking	W	10.25	4.95	-5.07	-15.08	-20.73	-15.05	-15.08	4.93	4.94
Q -TAS	W	NA	NA	NA	NA	0.00	0.00	-1.28	0.07	-0.70
Q-Final	W	-173.06	-82.47	74.80	142.16	172.57	186.90	136.19	-99.00	-82.87
RSI*	W·m ² ·K ⁻¹	1.82	1.93	2.12	2.23	2.29	1.68	2.33	1.57	1.92
R-Value*	ft ² ·F·h·Btu ⁻¹	10.35	10.94	12.02	12.64	13.01	9.52	13.22	8.89	10.87

*Thermal resistance calculated by dividing the total corrected heat flow by the surface area of the sample and the surface temperature differentials between the meter box and the climate box.

Ref Wall 6 2" Closed-cell SPF (Sealed 2 sides)		Test Regime (Interior Exterior Induced Airflow)				
	Units	22 62 none	22 42 none	22 2 none	22 -18 none	22 -28 none
Start Date	YY/MM/DD	11/12/17	11/12/15	11/12/07	11/12/09	11/12/12
End Date	YY/MM/DD	11/12/19	11/12/16	11/12/08	11/12/12	11/12/13
MB- Air Temp	C	22.06	21.96	21.67	21.44	21.35
CB- Air Temp	C	62.08	42.02	1.98	-17.96	-27.96
MB- Surf Temp	C	25.19	23.57	20.54	19.26	18.67
CB- Surf Temp	C	59.64	40.92	3.12	-15.50	-24.81
S-S Temp	C	34.46	17.35	-17.42	-34.76	-43.48
Q- Measured	W	-169.76	-79.69	75.17	147.46	181.94
Q-Air	W	0.43	0.21	-0.21	-0.42	-0.53
Q-Flanking	W	10.24	4.93	-5.08	-15.09	-20.78
Q -TAS	W	NA	NA	NA	NA	0.00
Q- Final	W	-159.52	-74.76	70.09	132.37	161.16
RSI*	W·m ² ·K ⁻¹	1.90	2.04	2.18	2.30	2.37
R-Value*	ft ² ·F·h·Btu ⁻¹	10.76	11.56	12.38	13.08	13.44

2015-06-18 – Thermal Metric Summary Report (June 2015 Update)

Ref Wall 6 2" Closed-cell SPF (as-built)		Test Regime (Interior Exterior Induced Airflow)					Induced Airflows (10Pa)			
	Units	22 62 none	22 42 none	22 2 none	22 -18 none	22 -28 none	22 -18 Inf	22 -18 Exf	22 42 Inf	22 42 Exf
Start Date	YY/MM/DD	11/12/01	11/11/18	11/10/29	11/11/04	11/11/15	11/11/09	11/11/12	11/11/22	11/11/25
End Date	YY/MM/DD	11/12/05	11/11/21	11/11/02	11/11/07	11/11/17	11/11/11	11/11/14	11/11/24	11/11/30
MB- Air Temp	F	71.62	71.44	71.06	70.56	70.37	70.41	70.54	71.50	71.46
CB- Air Temp	F	143.74	107.71	35.65	-0.34	-18.20	-0.34	-0.34	107.67	107.67
MB- Surf Temp	F	76.77	74.10	68.78	65.96	64.65	65.33	66.04	74.22	74.12
CB- Surf Temp	F	141.08	106.50	36.87	2.32	-14.85	2.18	2.36	105.80	106.45
S-S Temp	F	64.31	32.40	-31.91	-63.64	-79.49	-63.15	-63.68	31.58	32.34
Q- Measured	Btu/h	-625.41	-298.24	272.52	536.48	659.49	689.00	520.47	-354.61	-297.20
Q-Air	Btu/h	2.14	1.04	-3.69	-11.91	-20.73	160.83	-173.10	-40.75	45.39
Q-Flanking	Btu/h	34.97	16.88	-17.30	-51.45	-70.73	-51.35	-51.45	16.84	16.86
Q -TAS	Btu/h	NA	NA	NA	NA	0.00	0.00	-4.37	0.24	-2.40
Q- Final	Btu/h	-590.44	-281.36	255.21	485.03	588.76	637.65	464.65	-337.77	-282.74
RSI*	W·m ⁻² ·K ⁻¹	1.82	1.93	2.12	2.23	2.29	1.68	2.33	1.57	1.92
R-Value*	ft ² ·F·h·Btu ⁻¹	10.35	10.94	12.02	12.64	13.01	9.52	13.22	8.89	10.87

*Thermal resistance calculated by dividing the total corrected heat flow by the surface area of the sample and the surface temperature differentials between the meter box and the climate box.

Ref Wall 6 2" Closed-cell SPF (Sealed 2 sides)		Test Regime (Interior Exterior Induced Airflow)				
	Units	22 62 none	22 42 none	22 2 none	22 -18 none	22 -28 none
Start Date	YY/MM/DD	11/12/17	11/12/15	11/12/07	11/12/09	11/12/12
End Date	YY/MM/DD	11/12/19	11/12/16	11/12/08	11/12/12	11/12/13
MB- Air Temp	F	71.71	71.53	71.00	70.58	70.43
CB- Air Temp	F	143.74	107.64	35.57	-0.34	-18.34
MB- Surf Temp	F	77.70	74.60	68.51	65.64	64.34
CB- Surf Temp	F	139.35	105.66	37.62	4.10	-12.65
S-S Temp	F	61.65	31.05	-30.89	-61.54	-76.99
Q- Measured	Btu/h	-579.17	-271.89	256.45	503.10	620.74
Q-Air	Btu/h	1.45	0.73	-0.72	-1.43	-1.79
Q-Flanking	Btu/h	34.92	16.81	-17.32	-51.47	-70.88
Q -TAS	Btu/h	NA	NA	NA	NA	0.00
Q- Final	Btu/h	-544.25	-255.08	239.13	451.63	549.86
RSI*	W·m ⁻² ·K ⁻¹	1.90	2.04	2.18	2.30	2.37
R-Value*	ft ² ·F·h·Btu ⁻¹	10.76	11.56	12.38	13.08	13.44

Wall 6: R-Value– Sealed and As-Built

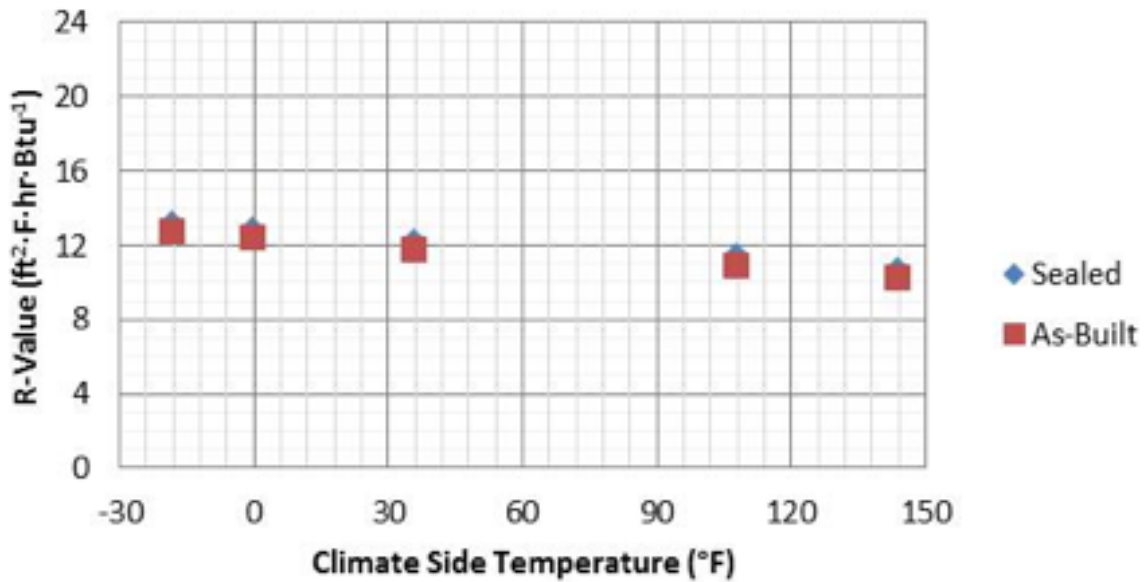

Wall 6: U-Value (Surface to Surface)

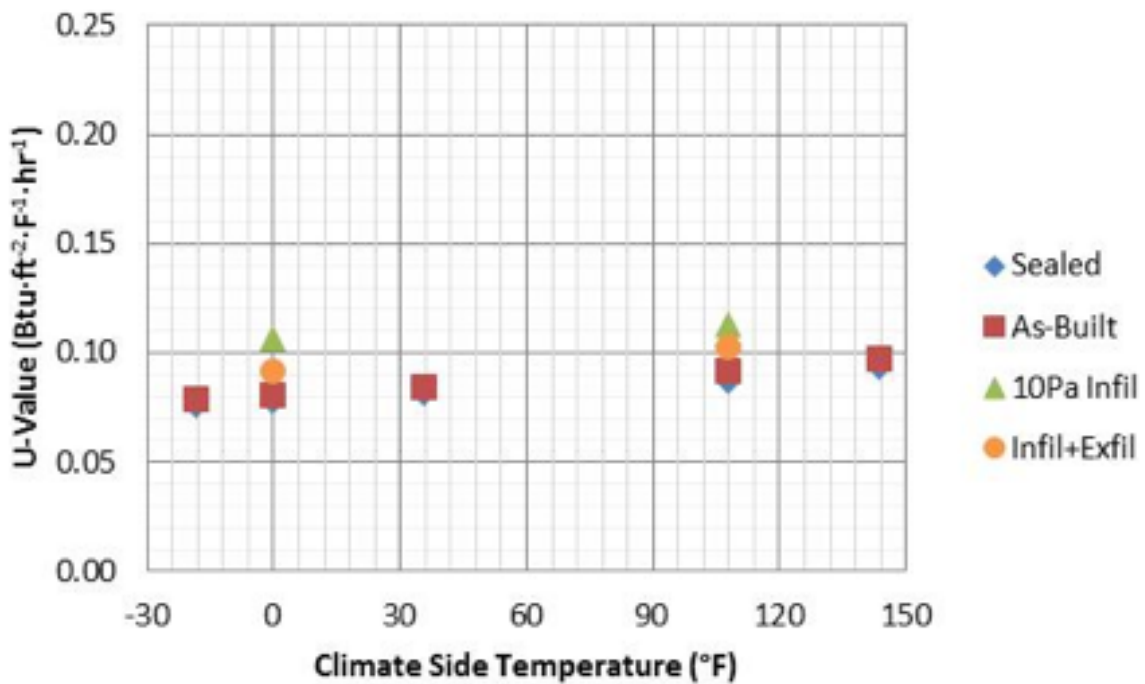

Wall 6: Building Energy Use per Wall

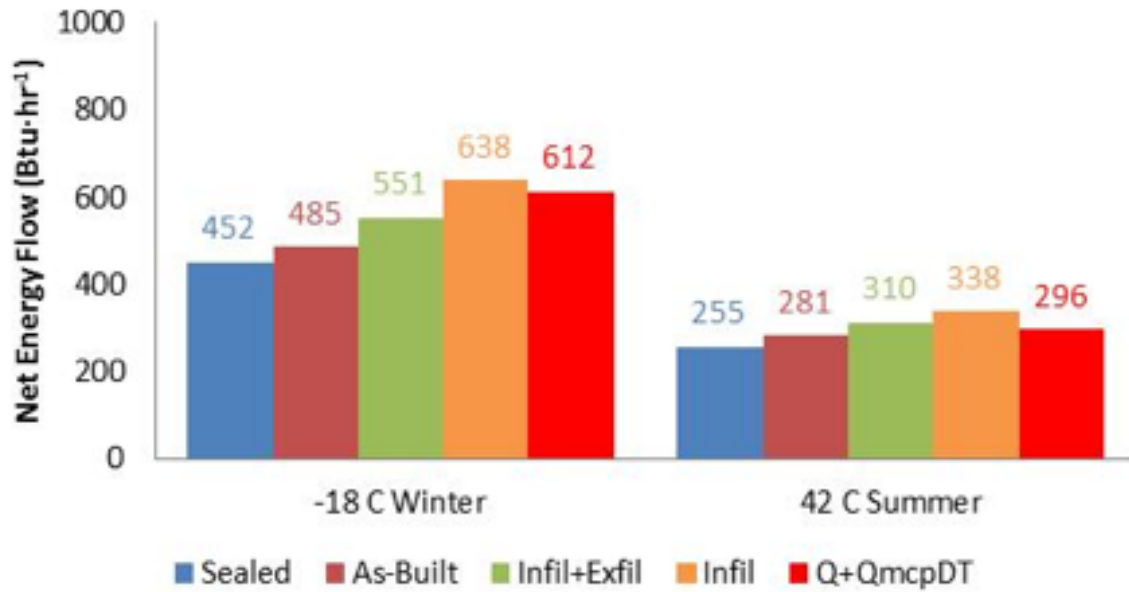

3.7 Reference Wall 7 – R13 FG + 1” XPS

Wall Name:	Reference Wall 7 – R13 F.G. Batt with 1” XPS Exterior Insulation	Build Date:	June, 2011
Reference Wall 7 comprises 2x4” S-P-F wood stud wall at 16” centers with un-faced, R-13 fiber glass batt insulation. The wall was sheathed with 1” XPS insulation, fastened via cap-screws following manufacturer’s recommendations.		Test Date:	June, 2011
		Researchers:	C. J. Schumacher A. P. Grin, P.Eng. R. T. Lepage, E.I.T.
Wall Dimensions	H: 2413mm (95.0”); L: 3635mm (143.125”)		
Wall Area:	8.775m ² (94.42 sq.ft)		
Interior Finish	½” Drywall with 1/32” gap provided by machined shims		
Inside Air Seal	None		
Frame	2x4 S-P-F wood studs at 16” OC		
Electrical	Two outlets and one switch, with wiring		
Insulation	3.5” R-13 kraft faced fibre glass batt insulation		
Sheathing	1” XPS with 1/32” gap provided by machined shims		
Outside Air Seal	None		
WRB 1	1” XPS		
Ext. Insulation	See: Sheathing		
WRB 2	None		
Drainspace	Integral in cladding		
Cladding	Vinyl Siding		
Framing Notes	2x4” S-P-F framing at 16” OC, double top plate, single bottom plate, and ½ width studs on edges		
Framing Factor	13.7%		

3.7.1 Material Properties

Material	Density		Moisture Content	Conductivity, k	R-Value / in.
	(kg/m ³)	(pcf)			
OSB Sheathing	599 ²	31.2	6-8% ²	0.0897 @ 23.9°C ³	1.61 @ 75°F ³
Spruce-Pine-Fir Framing	400 ¹	25	5-9% ²	0.0864 @ 23.9°C ³	1.67 @ 75°F ³
R-13 Kraft Faced Fiber Glass Batt	11.3 ⁴	0.70 ⁴	-	0.0356 @ 2°C ⁴ 0.0400 @ 23.9°C ⁴ 0.0418 @ 32°C ⁴	4.05 @ 35.6°F ⁴ 3.61 @ 75°F ⁴ 3.45 @ 89.6°F ⁴
1” XPS Insulation	27 ⁴	1.7 ⁴	-	0.0267 @ 2°C ⁴ 0.0291 @ 23.9°C ⁴ 0.0300 @ 32°C ⁴	5.40 @ 35.6°F ⁴ 4.96 @ 75°F ⁴ 4.81 @ 89.6°F ⁴
Drywall	660 ²	41.3	-	0.146 @ 23.9°C ³	0.988 @ 75°F ³

- Notes:
- 1) Assumed from ASHRAE Handbook of Fundamentals 2009
 - 2) Measured at Building Science Labs; random sampling of material lots purchased for multiple wall specimens
 - 3) Measured at Building Science Labs (ASTM C518); random sampling of material lot; conductivity and R-value reported at mean temperature indicated
 - 4) Measured at Building Science Labs (ASTM C518); sampling of actual insulation materials from the test wall specimen; conductivity and R-value reported at mean temperature indicated

3.7.2 Schematics

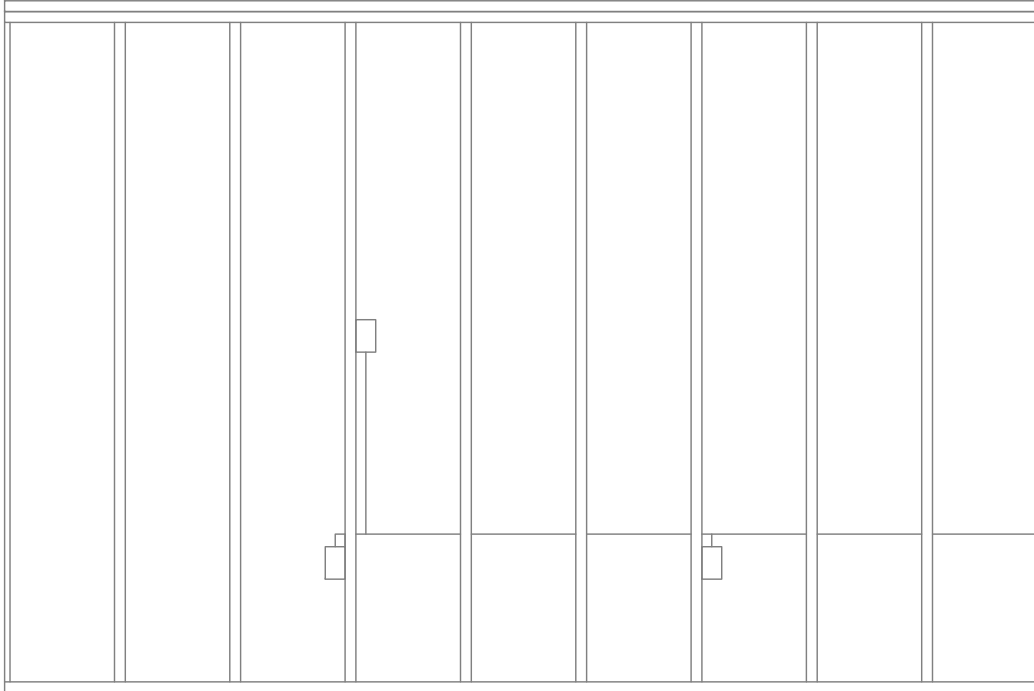

Figure 70 – Elevation of Framing & Electrical for Reference Wall 7 – 2x4 F.G. Batt with 1” XPS

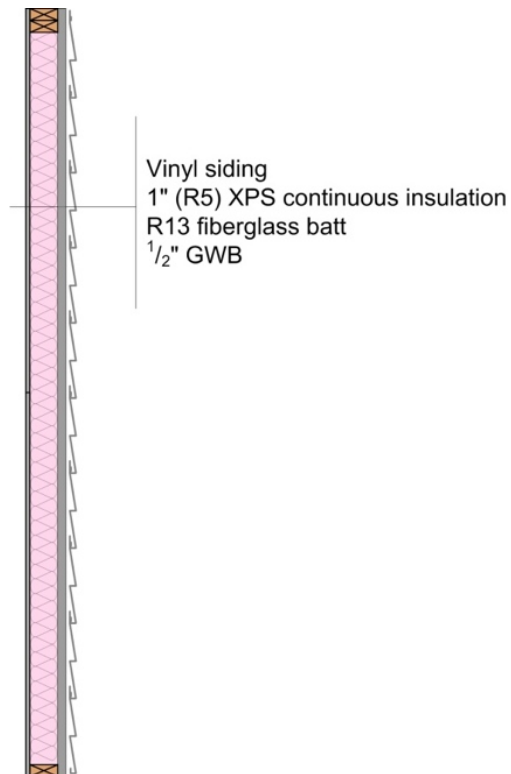

Figure 71 – Vertical Section for Reference Wall 7 – 2x4 F.G. Batt with 1” XPS

3.7.3 Notes

Pre-Construction	<ul style="list-style-type: none"> BSCI staff pre-assembled the wall frame and sheathing prior to installation of the insulation.
Construction	<ul style="list-style-type: none"> No industry partners were present to observe the installation of either the fiber glass batt or XPS insulation. BSCI staff carefully fitted Wall 7 fiber glass batt per NAIMA recommendations, as instructed by the industry partner who provided expertise for Wall 2. The exterior insulation was applied as per manufacturer’s recommendations. Although the manufacturer recommends nails, screws of equivalent length and shaft diameter were used to facilitate careful assembly and decommissioning. All partners agreed to substitute screws for the nails. The sheathing was installed using screws instead of nails. All partners agreed that the use of screws is an acceptable alternative for testing purposes.
Testing	<ul style="list-style-type: none"> No comments
Decommissioning	<ul style="list-style-type: none"> Samples of the wall specimen were taken for thermal conductivity testing.
General	<ul style="list-style-type: none"> The reference wall performed as anticipated.

3.7.4 Photos



3.7.5 Test Results

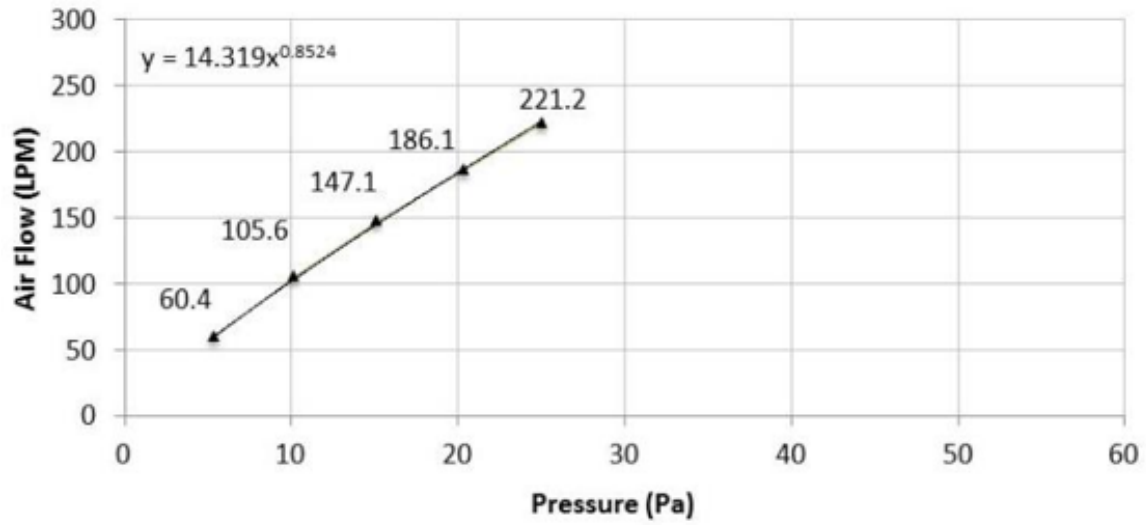

2015-06-18 – Thermal Metric Summary Report (June 2015 Update)

The results from the testing, at the specified temperature set points, are provided below. MB refers to the meter box; CB refers to the climate box.

Ref Wall 7 R13 FG Batt + R5 XPS (‘as-built’)		Test Regime (Interior Exterior Induced Airflow)					Induced Airflows (10Pa)			
	Units	22 62 none	22 42 none	22 2 none	22 -18 none	22 -28 none	22 -18 Inf	22 -18 Exf	22 42 Inf	22 42 Exf
Start Date	YY/MM/DD	11/06/23	11/06/18	11/06/03	11/06/08	11/06/15	11/06/10	11/06/14	11/06/20	11/06/21
End Date	YY/MM/DD	11/06/24	11/06/20	11/06/07	11/06/09	11/06/16	11/06/12	11/06/15	11/06/21	11/06/22
MB- Air Temp	C	21.90	21.84	21.57	21.32	21.22	21.14	21.47	21.86	21.82
CB- Air Temp	C	62.08	42.05	1.98	-17.96	-27.85	-17.87	-17.96	42.05	42.05
MB- Surf Temp	C	24.08	22.91	20.79	19.86	19.47	19.52	20.14	23.25	22.70
CB- Surf Temp	C	60.78	41.43	2.57	-16.61	-26.15	-16.77	-16.33	41.53	41.27
S-S Temp	C	36.69	18.52	-18.22	-36.47	-45.63	-36.29	-36.47	18.29	18.57
Q- Measured	W	-157.10	-80.22	65.92	131.44	162.65	215.22	106.66	-131.23	-79.65
Q-Air	W	2.57	0.79	-4.07	-12.23	-24.00	106.06	-79.98	-48.58	46.48
Q-Flanking	W	9.28	4.45	-4.85	-13.21	-17.89	-13.13	-13.27	4.45	4.46
Q -TAS	W	NA	NA	NA	NA	0.00	0.00	0.72	-0.16	7.18
Q-Final	W	-147.82	-75.77	61.06	118.23	144.76	202.10	94.11	-126.77	-68.01
RSI*	W·m ² ·K ⁻¹	2.18	2.14	2.62	2.71	2.77	1.58	3.40	1.27	2.40
R-Value*	ft ² ·F·h·Btu ⁻¹	12.37	12.18	14.87	15.37	15.70	8.95	19.31	7.19	13.61

*Thermal resistance calculated by dividing the total corrected heat flow by the surface area of the sample and the surface temperature differentials between the meter box and the climate box.

Ref Wall 7 R13 FG Batt + R5 XPS (‘Sealed 2 sides’)		Test Regime (Interior Exterior Induced Airflow)				
	Units	22 62 none	22 42 none	22 2 none	22 -18 none	22 -28 none
Start Date	YY/MM/DD	11/07/20	11/07/19	11/06/29	11/07/01	11/07/04
End Date	YY/MM/DD	11/07/21	11/07/20	11/06/30	11/07/04	11/07/05
MB- Air Temp	C	21.82	21.73	21.59	21.34	21.23
CB- Air Temp	C	62.07	42.04	1.97	-17.97	-27.95
MB- Surf Temp	C	24.40	23.03	20.61	19.36	18.83
CB- Surf Temp	C	60.06	41.03	2.92	-15.85	-25.20
S-S Temp	C	35.66	18.00	-17.69	-35.21	-44.02
Q- Measured	W	-147.68	-75.23	59.65	117.72	145.86
Q-Air	W	0.65	0.25	-0.20	-0.60	-0.75
Q-Flanking	W	9.30	4.48	-4.86	-13.22	-17.93
Q -TAS	W	NA	NA	NA	NA	NA
Q- Final	W	-138.38	-70.75	54.79	104.50	127.93
RSI*	W·m ² ·K ⁻¹	2.26	2.23	2.83	2.96	3.02
R-Value*	ft ² ·F·h·Btu ⁻¹	12.84	12.67	16.09	16.79	17.15

2015-06-18 – Thermal Metric Summary Report (June 2015 Update)

Ref Wall 7 R13 FG Batt + R5 XPS (‘as-built’)		Test Regime (Interior Exterior Induced Airflow)					Induced Airflows (10Pa)			
	Units	22 62 none	22 42 none	22 2 none	22 -18 none	22 -28 none	22 -18 Inf	22 -18 Exf	22 42 Inf	22 42 Exf
Start Date	YY/MM/DD	11/06/23	11/06/18	11/06/03	11/06/08	11/06/15	11/06/10	11/06/14	11/06/20	11/06/21
End Date	YY/MM/DD	11/06/24	11/06/20	11/06/07	11/06/09	11/06/16	11/06/12	11/06/15	11/06/21	11/06/22
MB- Air Temp	F	71.41	71.31	70.83	70.37	70.20	70.06	70.65	71.35	71.28
CB- Air Temp	F	143.74	107.69	35.56	-0.33	-18.13	-0.17	-0.32	107.70	107.69
MB- Surf Temp	F	75.76	73.49	68.95	66.73	65.73	65.55	67.42	74.15	73.21
CB- Surf Temp	F	141.40	106.58	36.62	2.10	-15.08	1.82	2.60	106.76	106.29
S-S Temp	F	65.63	33.08	-32.32	-64.63	-80.81	-63.73	-64.81	32.61	33.08
Q- Measured	Btu/h	-535.99	-273.70	224.90	448.46	554.92	734.30	363.90	-447.71	-271.75
Q-Air	Btu/h	8.75	2.70	-13.87	-41.67	-81.77	361.41	-272.55	-165.55	158.37
Q-Flanking	Btu/h	31.67	15.20	-16.56	-45.08	-61.02	-44.78	-45.26	15.19	15.21
Q -TAS	Btu/h	NA	NA	NA	NA	0.00	0.00	2.46	-0.54	24.50
Q- Final	Btu/h	-504.32	-258.50	208.34	403.38	493.90	689.52	321.10	-432.53	-232.03
RSI*	W·m ⁻² ·K ⁻¹	2.18	2.14	2.62	2.71	2.77	1.58	3.40	1.27	2.40
R-Value*	ft ² ·F·h·Btu ⁻¹	12.37	12.18	14.87	15.37	15.70	8.95	19.31	7.19	13.61

*Thermal resistance calculated by dividing the total corrected heat flow by the surface area of the sample and the surface temperature differentials between the meter box and the climate box.

Ref Wall 7 R13 FG Batt + R5 XPS (‘Sealed 2 sides’)		Test Regime (Interior Exterior Induced Airflow)				
	Units	22 62 none	22 42 none	22 2 none	22 -18 none	22 -28 none
Start Date	YY/MM/DD	11/07/20	11/07/19	11/06/29	11/07/01	11/07/04
End Date	YY/MM/DD	11/07/21	11/07/20	11/06/30	11/07/04	11/07/05
MB- Air Temp	F	71.27	71.11	70.86	70.41	70.22
CB- Air Temp	F	143.73	107.67	35.55	-0.35	-18.31
MB- Surf Temp	F	76.37	73.69	68.73	66.03	64.82
CB- Surf Temp	F	140.12	105.85	37.26	3.48	-13.35
S-S Temp	F	63.74	32.16	-31.47	-62.55	-78.17
Q- Measured	Btu/h	-503.85	-256.66	203.50	401.63	497.63
Q-Air	Btu/h	2.23	0.85	-0.68	-2.03	-2.54
Q-Flanking	Btu/h	31.72	15.27	-16.58	-45.11	-61.16
Q -TAS	Btu/h	NA	NA	NA	NA	NA
Q- Final	Btu/h	-472.12	-241.39	186.92	356.52	436.47
RSI*	W·m ⁻² ·K ⁻¹	2.26	2.23	2.83	2.96	3.02
R-Value*	ft ² ·F·h·Btu ⁻¹	12.84	12.67	16.09	16.79	17.15

Wall 7: R-Value– Sealed and As-Built

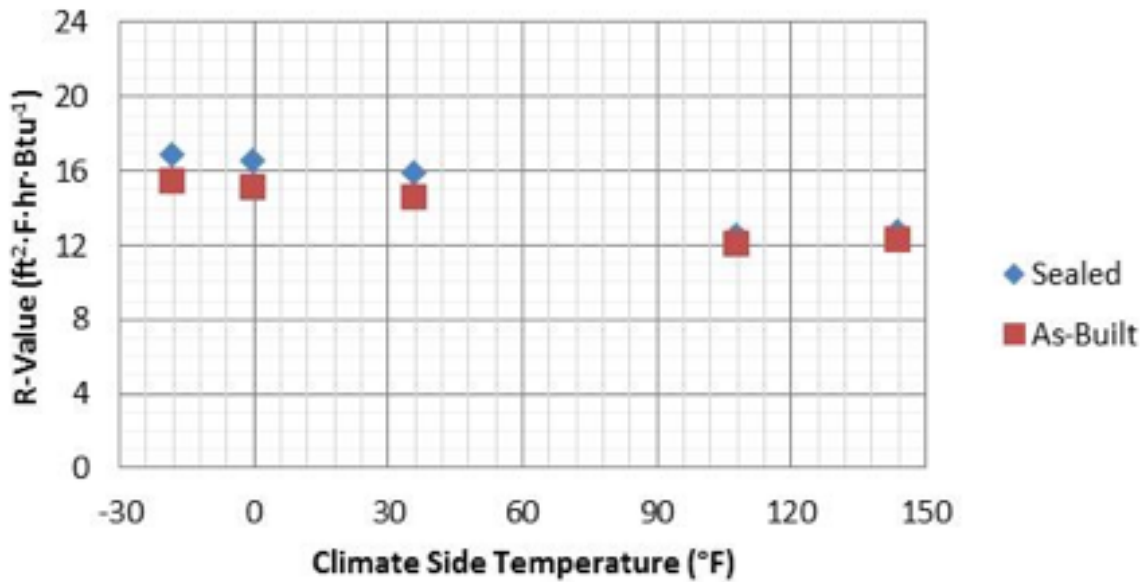

Wall 7: U-Value (Surface to Surface)

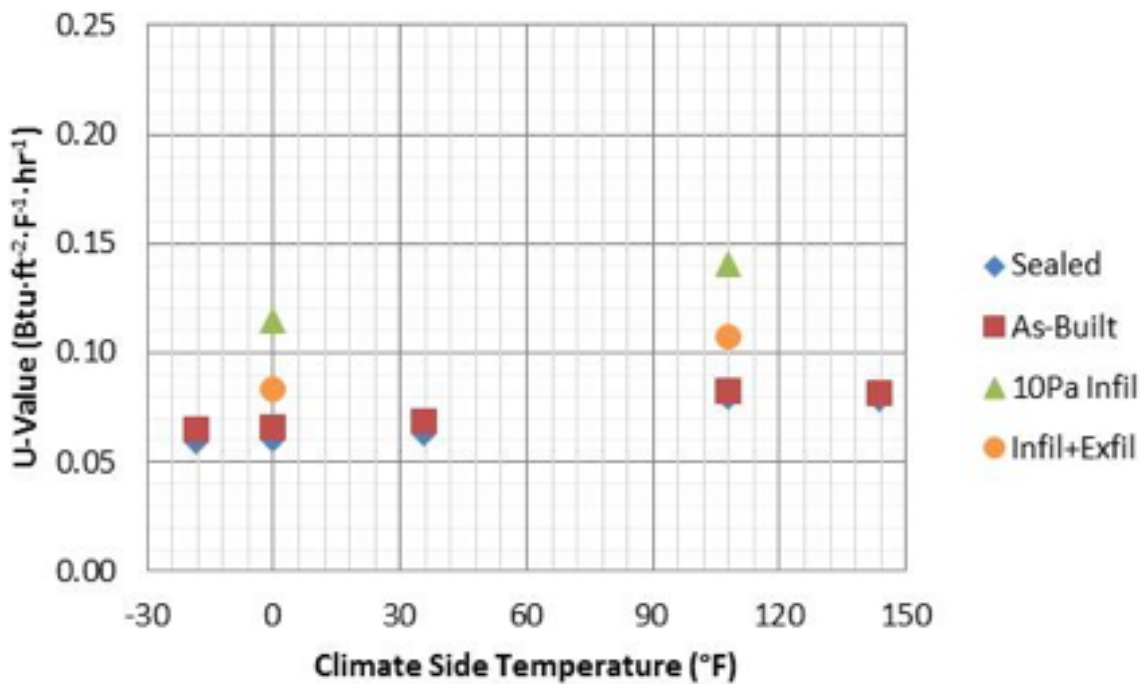

Wall 7: Building Energy Use per Wall

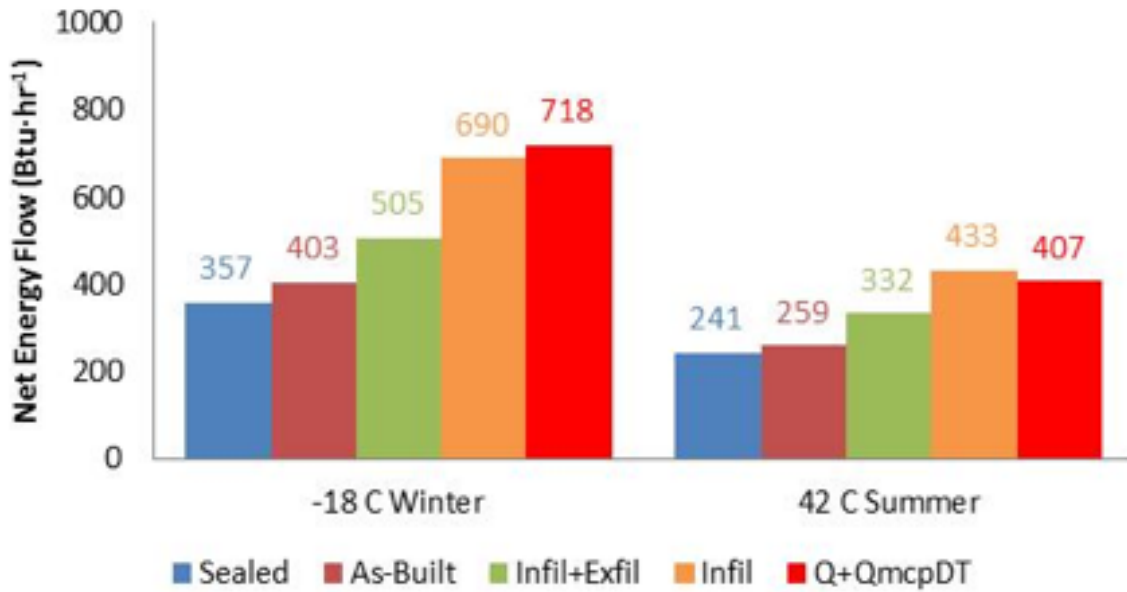

3.8 Reference Wall 8 – R21 Fiber glass Batt (2x6)

Wall Name:	Reference Wall 8 – R-21 F.G. Batt	Build Date:	January, 2012
Reference Wall 8 comprises 2x6" S-P-F wood stud wall at 16" centers with unfaced, R-21 fibre glass batt insulation. The wall was sheathed with 7/16" OSB sheathing.		Test Date:	January, 2012
		Researchers:	C. J. Schumacher A. P. Grin, P.Eng. R. T. Lepage, E.I.T.
Wall Dimensions	H: 2413mm (95.0"); L: 3635mm (143.125")		
Wall Area:	8.775m ² (94.42 sq.ft)		
Interior Finish	½" Drywall with 1/32" gap provided by machined shims		
Inside Air Seal	None		
Frame	2x6 S-P-F wood studs at 16" OC		
Electrical	Two outlets and one switch, with wiring		
Insulation	5.5" R-21 unfaced fibre glass batt insulation		
Sheathing	7/16" OSB with 1/32" gap provided by machined shims		
Outside Air Seal	None		
WRB 1	Tyvek Housewrap		
Ext. Insulation	None		
WRB 2	None		
Drainspace	Integral in cladding		
Cladding	Vinyl Siding		
Framing Notes	2x6" S-P-F framing at 16" OC, double top plate, single bottom plate, and ½ width studs on edges		
Framing Factor	13.7%		

3.8.1 Material Properties

Material	Density		Moisture Content	Conductivity, k	R-Value / in.
	(kg/m ³)	(pcf)			
OSB Sheathing	599 ²	37.4 ²	6-8% ²	0.0897 @ 23.9°C ³	1.61 @ 75°F ³
Spruce-Pine-Fir Framing	515 ²	32.3 ²	10-13% ²	0.160 @ 23.9°C ¹	0.901 @ 75°F ¹
R-21 Fiber Glass Batt	13.8 ⁴	0.864 ⁴	-	0.0344 @ 2°C ⁴ 0.0384 @ 23.9°C ⁴ 0.0400 @ 32°C ⁴	4.19 @ 35.6°F ⁴ 3.76 @ 75°F ⁴ 3.61 @ 89.6°F ⁴
Drywall	660 ²	41.3 ²	-	0.146 @ 23.9°C ³	0.988 @ 75°F ³

- Notes:
- 1) Assumed from ASHRAE Handbook of Fundamentals 2009
 - 2) Measured at Building Science Labs; random sampling of material lots purchased for multiple wall specimens
 - 3) Measured at Building Science Labs (ASTM C518); random sampling of material lot; conductivity and R-value reported at mean temperature indicated
 - 4) Measured at Building Science Labs (ASTM C518); sampling of actual insulation materials from the test wall specimen; conductivity and R-value reported at mean temperature indicated

3.8.2 Schematics

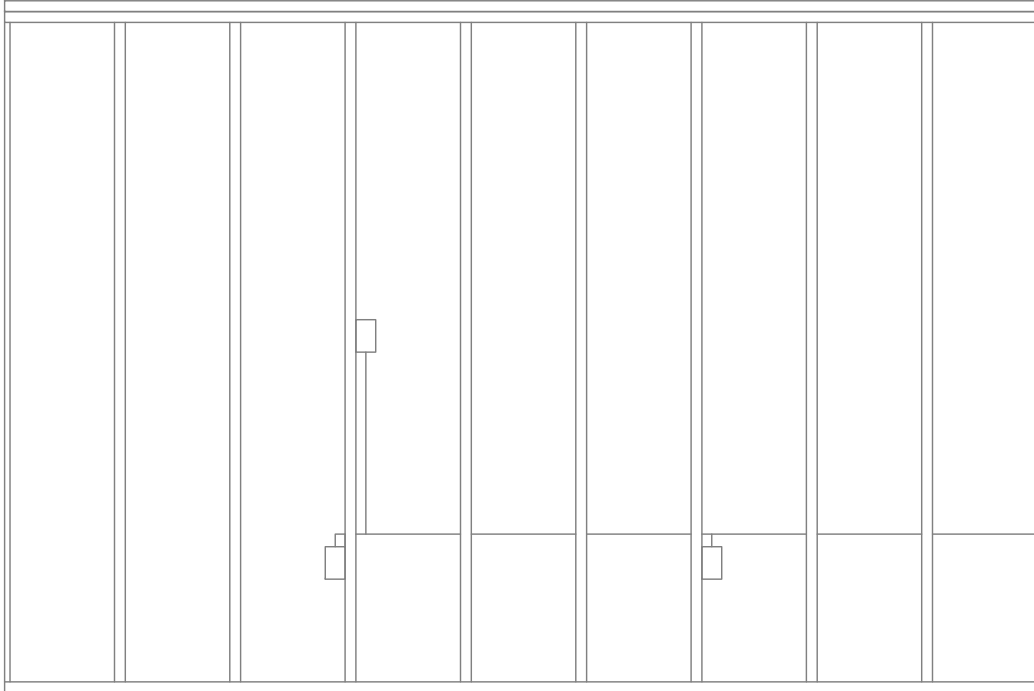

Figure 72 – Elevation of Framing & Electrical for Reference Wall 8 – 2x6 F.G. Batt

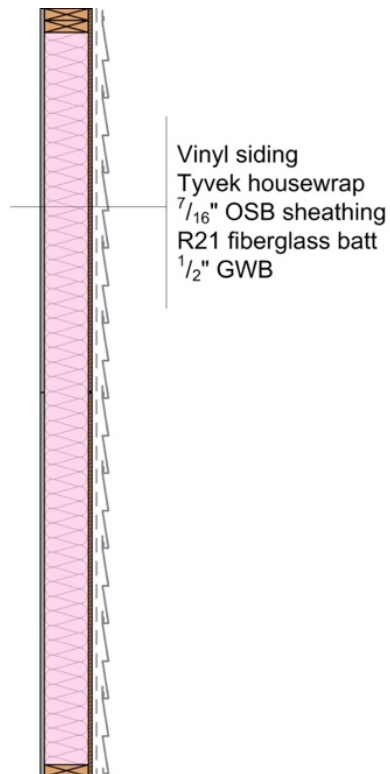
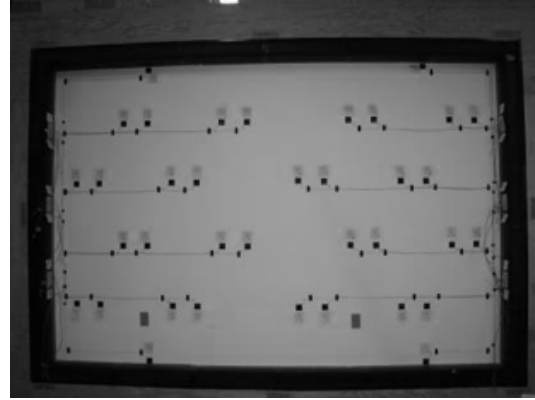
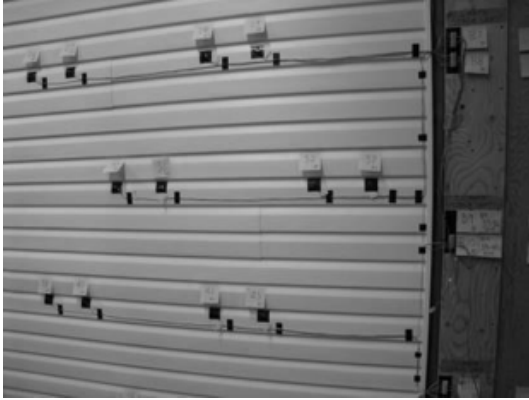

Figure 73 – Vertical Section for Reference Wall 8 – 2x6 F.G. Batt

3.8.3 Notes

Pre-Construction	<ul style="list-style-type: none"> BSCI staff pre-assembled the wall frame and sheathing prior to installation of the insulation.
Construction	<ul style="list-style-type: none"> BSCI staff carefully fitted Wall 8 fiber glass batt per NAIMA recommendations, as instructed by the industry partner who provided expertise for Wall 2. The sheathing was installed using screws instead of nails. All partners agreed that the use of screws is an acceptable alternative for testing purposes. The assembly design and construction did not include a poly vapor barrier.
Testing	<ul style="list-style-type: none"> No comments
Decommissioning	<ul style="list-style-type: none"> Samples of the wall specimen were taken for thermal conductivity testing.
General	<ul style="list-style-type: none"> The reference wall performed as anticipated.

3.8.4 Photos



3.8.5 Test Results

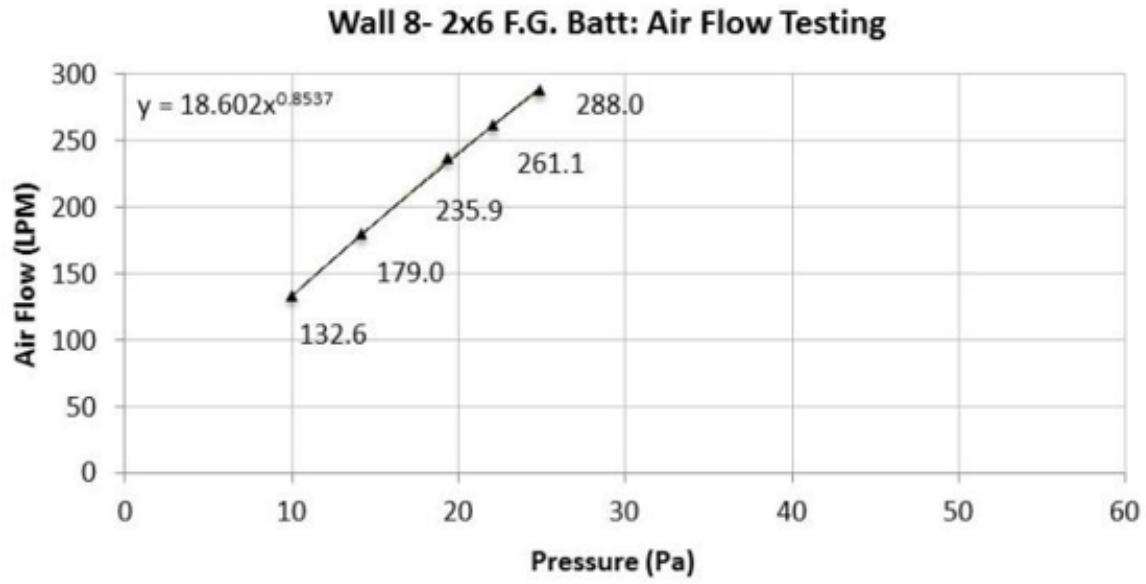

2015-06-18 – Thermal Metric Summary Report (June 2015 Update)

The results from the testing, at the specified temperature setpoints, are provided below. MB refers to the meter box; CB refers to the climate box.

Ref Wall 8 R21 FG Batt (‘as-built’)		Test Regime (Interior Exterior Induced Airflow)					Induced Airflows (10Pa)			
	Units	22 62 none	22 42 none	22 2 none	22 -18 none	22 -28 none	22 -18 Inf	22 -18 Exf	22 42 Inf	22 42 Exf
Start Date	YY/MM/DD	12/01/14	12/01/06	11/12/22	11/12/24	12/01/04	11/12/28	11/12/31	12/01/10	12/01/12
End Date	YY/MM/DD	12/01/16	12/01/07	11/12/23	11/12/28	12/01/05	11/12/29	12/01/03	12/01/11	12/01/13
MB- Air Temp	C	21.92	21.88	21.63	21.37	21.25	21.12	21.53	21.87	21.82
CB- Air Temp	C	62.02	42.02	2.02	-17.96	-27.75	-17.88	-17.96	42.04	42.03
MB- Surf Temp	C	23.74	22.79	20.88	19.94	19.53	19.41	20.39	23.06	22.52
CB- Surf Temp	C	60.86	41.49	2.51	-16.92	-26.54	-17.13	-16.60	41.65	41.40
S-S Temp	C	37.13	18.70	-18.37	-36.86	-46.08	-36.53	-36.99	18.59	18.88
Q- Measured	W	-141.50	-75.57	64.82	127.46	157.50	220.25	93.93	-102.30	-51.30
Q-Air	W	9.69	3.92	-6.45	-15.71	-21.32	126.94	-104.24	-52.15	50.72
Q-Flanking	W	6.86	3.26	-3.41	-9.81	-13.92	-9.73	-9.85	3.27	3.27
Q -TAS	W	NA	NA	NA	NA	0.00	0.00	-7.51	-0.16	5.33
Q-Final	W	-134.64	-72.31	61.42	117.65	143.58	210.53	76.57	-99.03	-42.70
RSI*	W·m ⁻² ·K ⁻¹	2.42	2.27	2.62	2.75	2.82	1.52	4.24	1.65	3.88
R-Value*	ft ² ·F·h·Btu ⁻¹	13.74	12.89	14.90	15.61	15.99	8.65	24.07	9.35	22.03

*Thermal resistance calculated by dividing the total corrected heat flow by the surface area of the sample and the surface temperature differentials between the meter box and the climate box.

Ref Wall 8 R21 FG Batt (‘Sealed 2 sides’)		Test Regime (Interior Exterior Induced Airflow)				
	Units	22 62 none	22 42 none	22 2 none	22 -18 none	22 -28 none
Start Date	YY/MM/DD	12/01/26	12/01/25	12/01/18	12/01/19	12/01/21
End Date	YY/MM/DD	12/01/27	12/01/25	12/01/19	12/01/20	12/01/23
MB- Air Temp	C	21.91	21.84	21.55	21.49	21.37
CB- Air Temp	C	62.10	42.11	2.01	-17.96	-27.96
MB- Surf Temp	C	24.45	23.09	20.73	19.77	19.26
CB- Surf Temp	C	60.45	41.41	2.71	-16.46	-25.97
S-S Temp	C	36.01	18.32	-18.02	-36.23	-45.23
Q- Measured	W	-129.84	-61.95	56.27	110.57	138.21
Q-Air	W	0.50	0.25	-0.32	-0.64	-0.80
Q-Flanking	W	6.88	3.28	-3.39	-9.84	-14.01
Q -TAS	W	NA	NA	NA	NA	0.00
Q-Final	W	-122.96	-58.67	52.88	100.73	124.19
RSI*	W·m ⁻² ·K ⁻¹	2.57	2.74	2.99	3.16	3.20
R-Value*	ft ² ·F·h·Btu ⁻¹	14.59	15.56	16.98	17.92	18.15

2015-06-18 – Thermal Metric Summary Report (June 2015 Update)

Ref Wall 8 R21 FG Batt (‘as-built’)		Test Regime (Interior Exterior Induced Airflow)					Induced Airflows (10Pa)			
	Units	22 62 none	22 42 none	22 2 none	22 -18 none	22 -28 none	22 -18 Inf	22 -18 Exf	22 42 Inf	22 42 Exf
Start Date	YY/MM/DD	12/01/14	12/01/06	11/12/22	11/12/24	12/01/04	11/12/28	11/12/31	12/01/10	12/01/12
End Date	YY/MM/DD	12/01/16	12/01/07	11/12/23	11/12/28	12/01/05	11/12/29	12/01/03	12/01/11	12/01/13
MB- Air Temp	F	71.45	71.38	70.94	70.46	70.25	70.02	70.75	71.37	71.28
CB- Air Temp	F	143.63	107.64	35.64	-0.33	-17.95	-0.18	-0.34	107.66	107.65
MB- Surf Temp	F	75.28	73.32	69.13	66.97	65.96	65.65	67.92	73.81	72.87
CB- Surf Temp	F	141.56	106.69	36.51	1.54	-15.78	1.17	2.12	106.97	106.51
S-S Temp	F	66.27	33.37	-32.62	-65.42	-81.74	-64.48	-65.81	33.16	33.64
Q- Measured	Btu/h	-482.76	-257.83	221.16	434.86	537.37	751.46	320.46	-349.01	-175.04
Q-Air	Btu/h	33.01	13.35	-21.98	-53.54	-72.65	432.56	-355.22	-177.69	172.83
Q-Flanking	Btu/h	23.41	11.13	-11.62	-33.47	-47.50	-33.18	-33.61	11.14	11.17
Q -TAS	Btu/h	NA	NA	NA	NA	0.00	0.00	-25.62	-0.55	18.18
Q-Final	Btu/h	-459.35	-246.70	209.54	401.39	489.87	718.27	261.23	-337.87	-145.69
RSI*	W·m ⁻² ·K ⁻¹	2.42	2.27	2.62	2.75	2.82	1.52	4.24	1.65	3.88
R-Value*	ft ² ·F·h·Btu ⁻¹	13.74	12.89	14.90	15.61	15.99	8.65	24.07	9.35	22.03

*Thermal resistance calculated by dividing the total corrected heat flow by the surface area of the sample and the surface temperature differentials between the meter box and the climate box.

Ref Wall 8 R21 FG Batt (‘Sealed 2 sides’)		Test Regime (Interior Exterior Induced Airflow)				
	Units	22 62 none	22 42 none	22 2 none	22 -18 none	22 -28 none
Start Date	YY/MM/DD	12/01/26	12/01/25	12/01/18	12/01/19	12/01/21
End Date	YY/MM/DD	12/01/27	12/01/25	12/01/19	12/01/20	12/01/23
MB- Air Temp	F	71.44	71.32	70.79	70.69	70.46
CB- Air Temp	F	143.78	107.79	35.61	-0.34	-18.33
MB- Surf Temp	F	76.00	73.56	68.92	66.84	65.72
CB- Surf Temp	F	140.81	106.53	36.88	2.37	-14.74
S-S Temp	F	64.81	32.97	-32.03	-64.47	-80.46
Q- Measured	Btu/h	-442.98	-211.36	192.00	377.25	471.54
Q-Air	Btu/h	1.69	0.85	-1.08	-2.19	-2.74
Q-Flanking	Btu/h	23.46	11.20	-11.58	-33.57	-47.82
Q -TAS	Btu/h	NA	NA	NA	NA	0.00
Q-Final	Btu/h	-419.53	-200.16	180.41	343.67	423.72
RSI*	W·m ⁻² ·K ⁻¹	2.57	2.74	2.99	3.16	3.20
R-Value*	ft ² ·F·h·Btu ⁻¹	14.59	15.56	16.98	17.92	18.15

Wall 8: R-Value– Sealed and As-Built

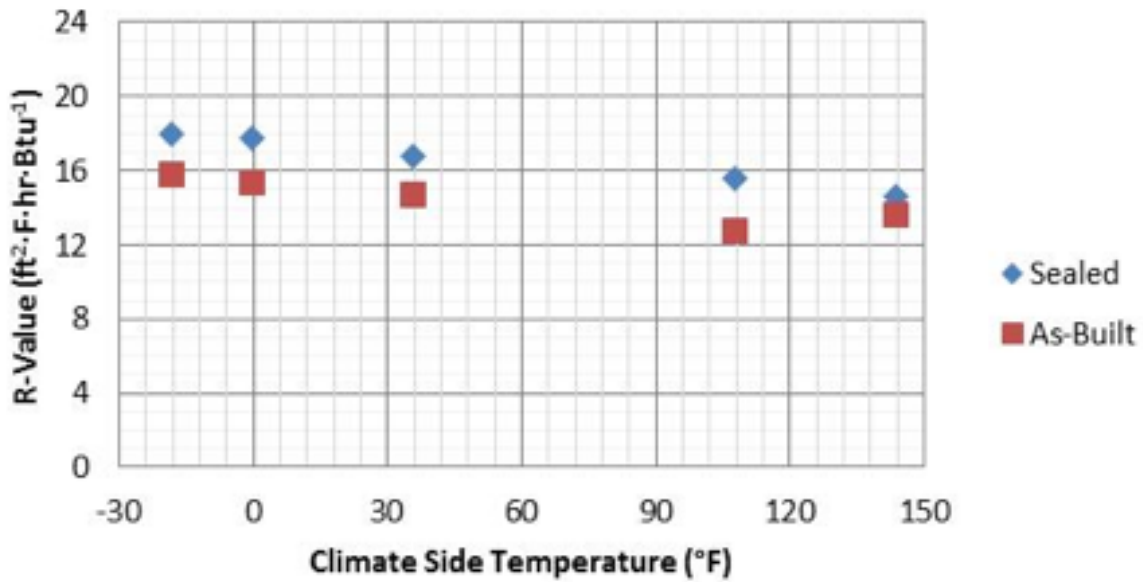

Wall 8: U-Value (Surface to Surface)

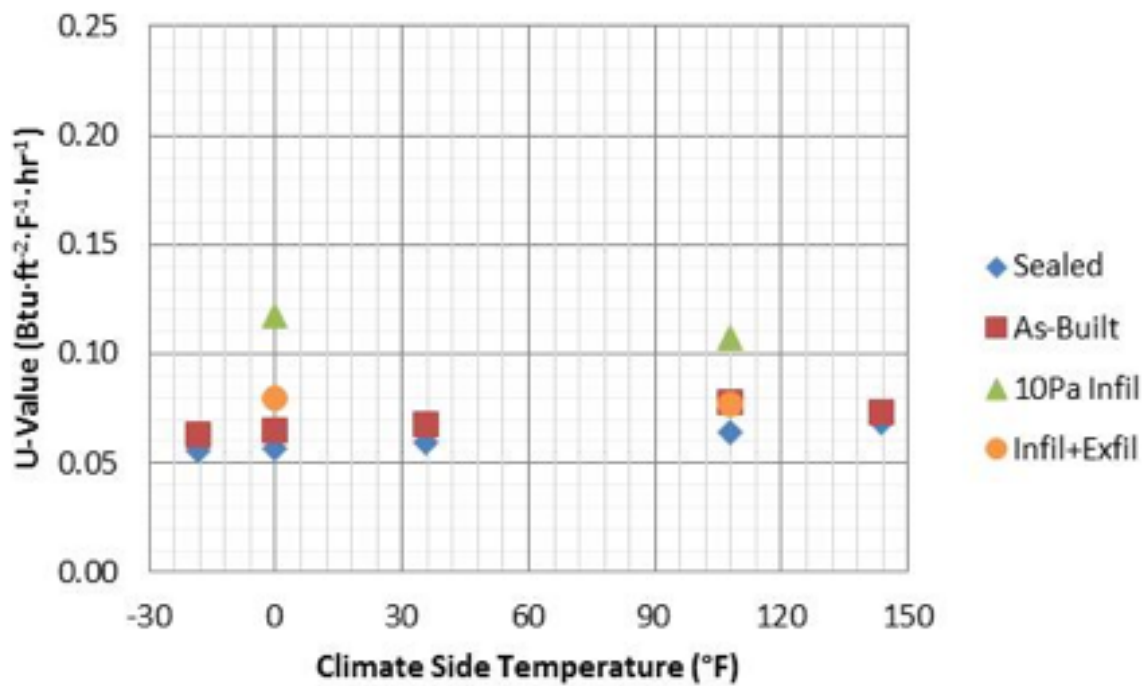

Wall 8: Building Energy Use per Wall

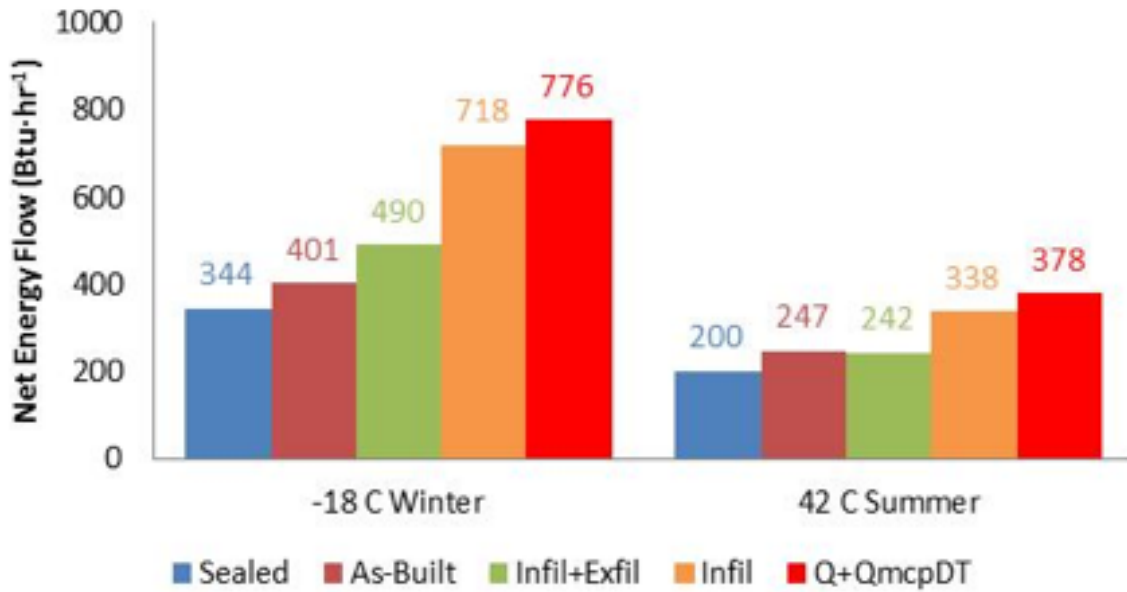

4 Discussion and Conclusions

A number of important and interesting observations have come out of the Reference Wall testing:

- When walls are constructed with the same installed R-value in the stud space, and are air sealed both inside and outside (i.e. there is effectively zero air leakage through the assembly), they exhibit essentially the same thermal performance regardless of the type of insulation material used.
- All of the tested wall assemblies were subject to thermal bridging regardless of the type of insulation material used in the stud space. Thermal bridging through the framing resulted in a roughly 15% decrease in thermal performance.
- Commercially available 2D and 3D heat transfer models provided good predictions of the thermal bridging in the assemblies tested, as did the parallel path method described in the ASHRAE Handbook of Fundamentals and other texts.
- All of the insulation materials exhibited temperature-dependent thermal performance (i.e. changes in insulation R-value with changes in mean temperature). The mechanisms that explain this phenomenon are well understood; however, there is a lack of relevant material-property information (i.e. measurements of insulation R-value at different temperatures).
- In this study, temperature dependency of insulation R-value was accounted for by material-specific thermal conductivity measurements (made at the hot-box test temperatures). The temperature-dependence effect resulted in improved thermal performance at lower mean temperatures (e.g. an outdoor temperature of 0°F, -18°C resulted in roughly a 10% improvement in thermal performance of the insulation) and reduced thermal performance at higher mean temperatures (e.g. an outdoor temperature of 144°F, 62°C resulted in roughly a 15% decrease in thermal performance of the insulation).
- All of the reference test wall assemblies were subjected to significant temperature differences: up to 50°C or 90°F in the winter tests and up to 40°C or 72°F in the summer tests. Natural convective looping was not noted in any of the wall assemblies.
- All wall assemblies experienced a loss in thermal performance due to air movement through the assembly. This is true for all of the assemblies tested regardless of the type of insulation material used (e.g. cellulose, fiber glass, ocSPF, ccSPF, XPS).
- The energy impact of airflow depends on the flow path, the interaction between the air and the solid materials in the assembly, and the installed R-value of the assembly.
- Conventional energy models (i.e. those that account for air leakage energy using $Q=mcdT$) may over-predict the negative energy impact on walls that have a significant interaction effect (e.g. air moving through insulation).

5 Acknowledgements

Building Science Corporation recognizes the contributions of the many organizations and people that made this project possible.

Industry Partners:

- Dow Building Solutions
- Honeywell
- Huntsman Polyurethanes
- Icynene
- North America Insulation Manufacturer's Association (NAIMA)
- Greenfiber

Advisory Committee:

- Mary Bogdan (Honeywell)
- Dave Bowman (Greenfiber)
- Bohdan Boyko (Greenfiber)
- John Broniek (Icynene)
- Charles Cottrell (NAIMA)
- Paul Duffy (Icynene)
- Rick Duncan (formerly of Honeywell)
- Gabe Farkas (retired from Icynene)
- Doug Fast (formerly of Johns Manville, on behalf of NAIMA)
- Stan Gatland (CertainTeed, on behalf of NAIMA)
- Monica Karamagi (Huntsman)
- Mike Mazor (Dow)
- Dave Ober (formerly of Greenfiber).
- Gary Parsons (Dow)
- Xuaco Pascual (Honeywell)
- Ed Reeves (retired from Icynene)
- John B. Smith (retired from Johns Manville, working on behalf of NAIMA)

Special recognition goes to John B. Smith and Dave Ober, who participated in this project from the beginning and continued to be heavily engaged beyond their employment with the industry partners. Dave and John were involved heavily in data analysis, interpretation and editing of drafts.

Appendix A – Test Results for Select Proprietary Walls

1 Thermal Performance Test Report- Sample Characteristics

Wall Name:	R-15 Fiber glass batt	Build Date:	July 2013
<p>The R-15 fiber glass batt private wall consists of 2x4" SPF wood stud wall at 16" centers with 3.5" R-15 fibre glass batt insulation with kraft face vapor retarder with flanges stapled to the face of the studs. The wall was sheathed with 7/16" OSB sheathing with all joints sealed with Latex caulking on the interior side. A layer of housewrap was installed on the exterior of the sheathing, which functioned as the drainage plane.</p>		Test Date:	August 2014
		Researchers:	Aaron Grin, P.Eng.
Wall Dimensions	H: 2413mm (95.0"); L: 3635mm (143.125")		
Wall Area:	8.775m ² (94.42 sq.ft)		
Interior Finish	½" Drywall		
Inside Air Seal	1/32" shimmed gap on inside and outside of the top and bottom plates		
Frame	2x4 SPF wood studs at 16" OC		
Electrical	Two outlets and one switch, with wiring		
Insulation	3.5" of R-15 fiber glass batt insulation with face stapled kraft facing		
Sheathing	7/16" OSB (with 1/32" gap via machined shims)		
Outside Air Seal	OSB joints and all studs bays were picture-frame sealed using latex caulking.		
WRB 1	Housewrap		
Ext. Insulation	N/A		
WRB 2	N/A		
Drainspace	N/A		
Cladding	Vinyl Siding		
Framing Notes	2x4" SPF framing at 24" OC, double top plate, single bottom plate, and ½ studs on edges		
Framing Factor	14.7%		
Notes:	Wood components were seasoned at laboratory temperature and humidity conditions.		

Material	Density		Moisture Content (%wt)	Conductivity, k (W/m·°K)	R-Value / in. (Ft ² ·°F·hr/Btu·in)
	(kg/m ³)	(pcf)			
OSB Sheathing	599 ²	31.2	6-8% ²	0.0897 @ 23.9°C ³	1.61 @ 75°F ³
Spruce-Pine-Fir Framing	400 ¹	25	5-9% ²	0.0864 @ 23.9°C ³	1.67 @ 75°F ³
R-15 Fiber Glass Batt	21.6 ⁴	1.35 ⁴	-	0.0346 @ 23.9°C ⁴	4.17 @ 75°F ⁴
Drywall	660 ²	41.3	-	0.146 @ 23.9°C ³	0.988 @ 75°F ³

- Notes:
- 1) Assumed from ASHRAE Handbook of Fundamentals 2009
 - 2) Measured at Building Science Labs; random sampling of material lots purchased for multiple wall specimens
 - 3) Measured at Building Science Labs (ASTM C518); random sampling of material lot; conductivity & R-value reported at mean temperature indicated
 - 4) Measured at Building Science Labs (ASTM C518); sampling of actual insulation materials from the test wall specimen; conductivity & R-value reported at mean temperature indicated

2 Thermal Performance Test Report- Test Results

The results from the testing, at the specified temperature setpoints, are provided below in tabular and graphic format. MB refers to the meter box, while CB refers to the climate box.

R-15 Fiber glass batt		Test Regime (Interior Exterior Induced Air Flow)					Induced Air Flows (10 Pa)			
	(°C)	22 62	22 42	22 2	22 -18	22 -28	22 -18 10Pa	22 -18 10Pa	22 42 10Pa	22 42 10Pa
	(°F)	72 144	72 108	72 36	72 0	72	72 0 10Pa	72 0 10Pa	72 108 10Pa	72 108 10Pa
Start Date	YY/MM/DD	13/07/31	13/08/13	13/09/24	13/09/28	14/06/26	13/10/01	13/10/02	13/07/25	13/07/27
End Date	YY/MM/DD	13/08/02	13/08/14	13/09/25	13/09/30	14/06/28	13/10/02	13/10/04	13/07/26	13/07/30
MB - Air Temp	°C	21.85	21.79	21.60	21.37	21.21	21.25	21.39	21.84	21.83
CB - Air Temp	°C	62.00	42.00	2.00	-18.00	-28.00	-18.00	-18.00	42.00	42.00
MB - Surf Temp	°C	24.82	23.28	20.06	18.51	17.72	18.27	18.62	23.21	23.14
CB - Surf Temp	°C	60.57	40.45	2.52	-16.64	-26.56	-16.70	-16.55	41.25	41.23
S-S Temp Diff	°C	35.75	17.17	-17.54	-35.14	-44.27	-34.96	-35.17	18.04	18.09
Q - Measured	W	-182.36	-82.22	76.82	149.20	179.82	170.04	144.17	-87.79	-78.18
Q - Air	W	2.39	0.79	-0.98	-4.27	-5.34	-27.75	-33.97	6.22	6.88
Q - Flanking	W	10.27	4.96	-5.05	-15.08	-20.73	-15.03	-15.08	4.95	4.95
Q - Qtas	W	NA	NA	NA	NA	NA	0.00	-0.94	1.00	-3.87
Q - Net	W	-172.09	-77.25	71.77	134.12	159.08	155.01	128.14	-82.83	-77.09
RSI	(m ² K/W)	1.82	1.95	2.15	2.30	2.44	1.98	2.41	1.91	2.06
R-Value	(ft ² F·h/Btu)	10.35	11.08	12.18	13.06	13.87	11.24	13.68	10.85	11.69

*Thermal resistance calculated by dividing the total corrected heat flow by the surface area of the sample and the surface temperature differentials between the meter box and the climate box.

The total heat flow (Q_{total}) is calculated by using the measured heat flow required to maintain 72°F(22°C) ($Q_{measure}$) then applying correction factors for the heat moved from airflow (Q_{air}) and the amount of heat that bypasses the wall cartridge ($Q_{flanking}$). The R-value is obtained by multiplying the wall area and

surface-to-surface (S-S) temperature difference by the inverse of the total heat flow. The R-values at each climate box setpoint, including the induced air flow R-values, are provided in the plot below.

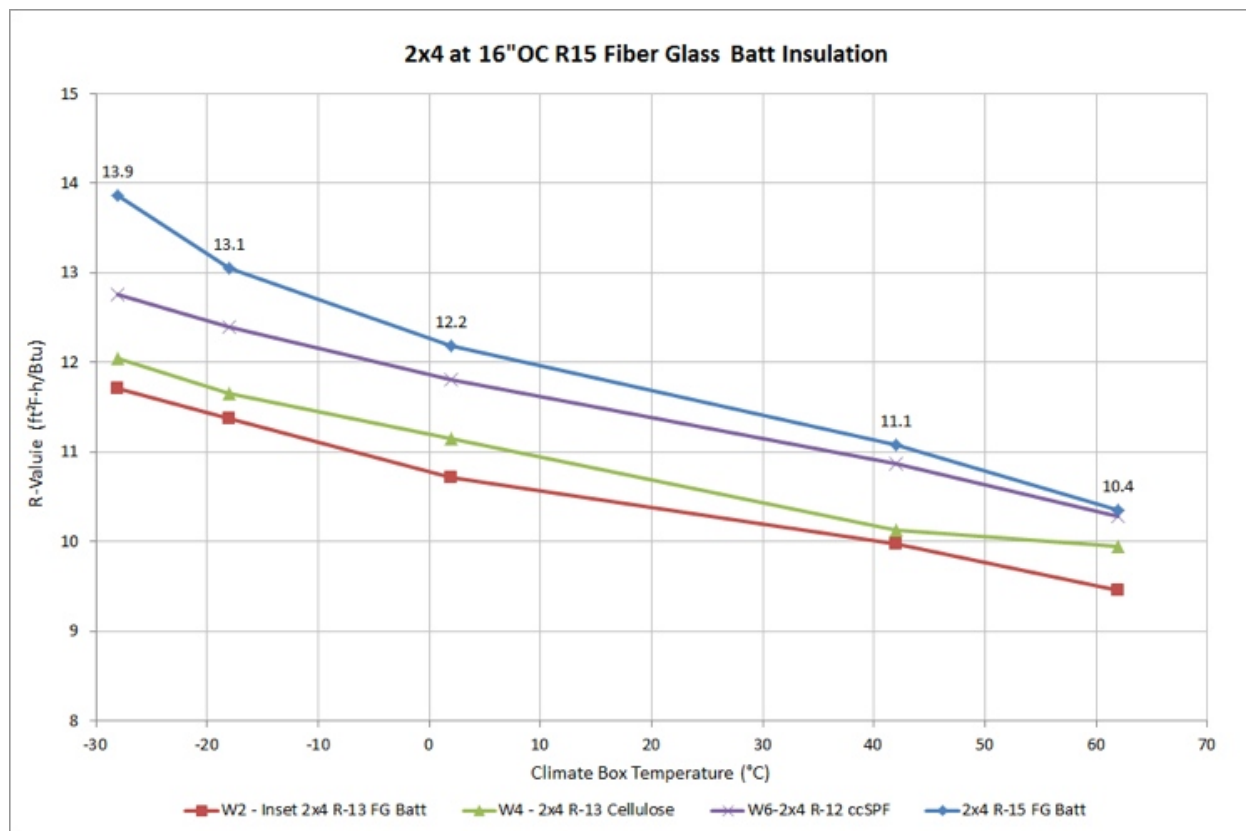

The ASTM C518 thermal conductivity test data are presented in the following table.

Sample ID	T _{mean} (C)	T _{mean} (F)	Lambda (W/mW)	Thickness (m)	RSI (m ² K/W)	R (°F-ft ² - hr/Btu)	R-inch
Ex1	43.3	110.0	0.03804	0.089	2.339	13.3	3.8
	42.0	107.6	0.03774	0.089	2.358	13.4	3.8
	23.9	75.1	0.03497	0.089	2.545	14.4	4.1
	4.5	40.1	0.03231	0.089	2.754	15.6	4.5
	2.0	35.6	0.03206	0.089	2.776	15.8	4.5
	-3.9	25.0	0.03108	0.089	2.863	16.3	4.6
Ex2	43.3	110.0	0.03753	0.089	2.371	13.5	3.8
	42.0	107.6	0.03715	0.089	2.395	13.6	3.9
	23.9	75.1	0.03423	0.089	2.600	14.8	4.2
	4.5	40.1	0.03188	0.089	2.791	15.8	4.5
	2.0	35.6	0.03158	0.089	2.818	16.0	4.6
	-3.9	25.0	0.03067	0.089	2.902	16.5	4.7

T_{mean} represents the average temperature between the upper and lower plates of the test apparatus.

R-15 Fiber Glass Batt w/ Latex Caulk Air Sealing – Report Summary

The thermal resistances calculated for each T_{mean} used in the C518 testing are presented in the plot below.

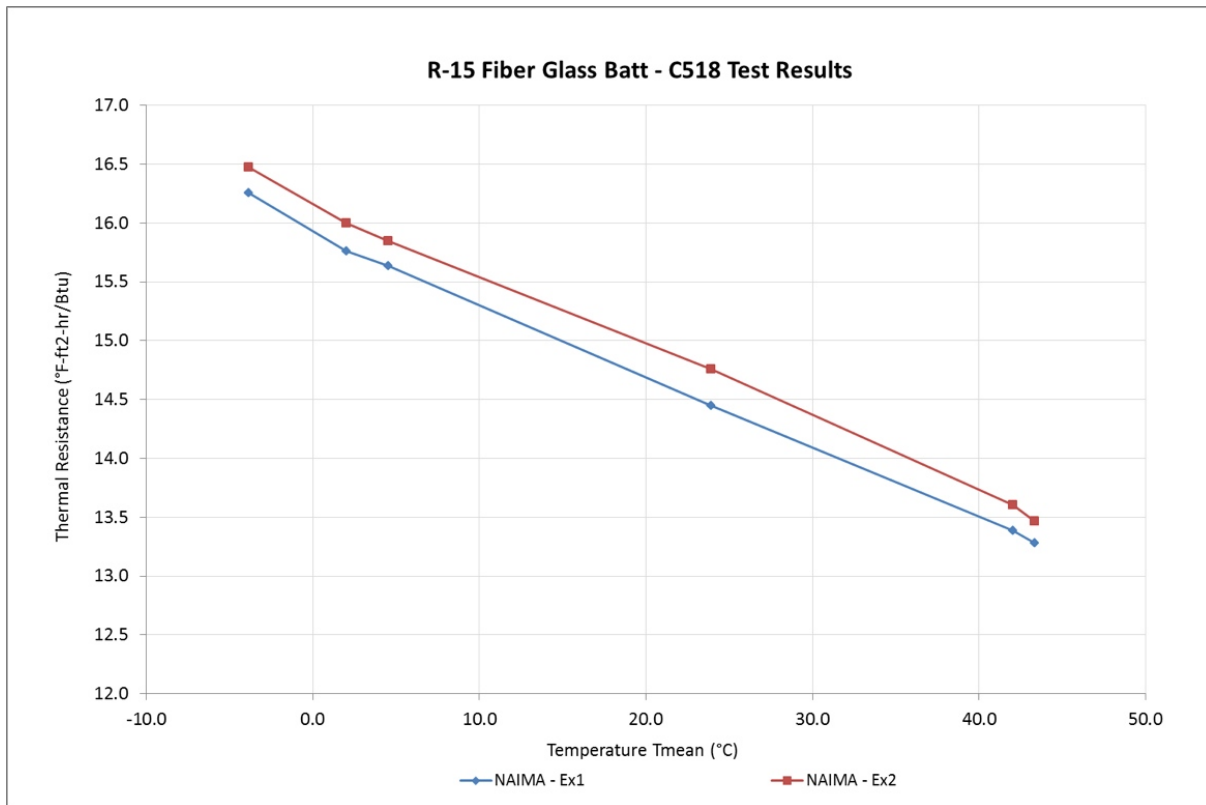

1 Thermal Performance Test Report- Sample Characteristics

Wall Name:	R-15 Dense-Pack Fiberglass	Build Date:	August 2014
The R-15 Dense-Pack Fiberglass Private Wall consists of 2x4" SPF wood stud wall at 16" centers with 3.5" dense pack fiberglass blowing insulation. The wall was sheathed with 7/16" OSB sheathing with all joints sealed with Latex caulking on the interior side. A layer of housewrap was installed on the exterior of the sheathing, which functioned as the drainage plane.		Test Date:	September 2014
		Researchers:	Aaron Grin, P.Eng.
Wall Dimensions	H: 2413mm (95.0"); L: 3635mm (143.125")		
Wall Area:	8.775m ² (94.42 sq.ft)		
Interior Finish	½" Drywall		
Inside Air Seal	1/32" shimmed gap on inside and outside of the top and bottom plates		
Frame	2x4 SPF wood studs at 16" OC		
Electrical	Two outlets and one switch, with wiring		
Insulation	3.5" of R-15 Dense-Pack Fiberglass insulation (1.8 pcf)		
Sheathing	7/16" OSB (with 1/32" gap via machined shims)		
Outside Air Seal	OSB joints and all studs bays were picture-frame sealed using latex caulking.		
WRB 1	Housewrap		
Ext. Insulation	N/A		
WRB 2	N/A		
Drainspace	N/A		
Cladding	Vinyl Siding		
Framing Notes	2x4" SPF framing at 16" OC, double top plate, single bottom plate, and ½ studs on edges		
Framing Factor	14.7%		
Notes:	Wood components were seasoned at laboratory temperature and humidity conditions.		

Material	Density		Moisture Content	Conductivity, k	R-Value / in.
	(kg/m ³)	(pcf)	(%wt)	(W/m·°K)	(Ft ² ·°F·hr/Btu-in)
OSB Sheathing	599 ²	31.2	6-8% ²	0.0897 @ 23.9°C ³	1.61 @ 75°F ³
Spruce-Pine-Fir Framing	400 ¹	25	5-9% ²	0.0864 @ 23.9°C ³	1.67 @ 75°F ³
R-15 Dense-Packed Fiber Glass	28.6 ⁴	1.78 ⁴	-	0.0348 @ 23.9°C ⁴	4.15 @ 75°F ⁴
Drywall	660 ²	41.3	-	0.146 @ 23.9°C ³	0.988 @ 75°F ³

- Notes:
- 1) Assumed from ASHRAE Handbook of Fundamentals 2009
 - 2) Measured at Building Science Labs; random sampling of material lots purchased for multiple wall specimens
 - 3) Measured at Building Science Labs (ASTM C518); random sampling of material lot; conductivity & R-value reported at mean temperature indicated
 - 4) Measured at Building Science Labs (ASTM C518); sampling of actual insulation materials from the test wall specimen; conductivity & R-value reported at mean temperature indicated

2 Thermal Performance Test Report- Test Results

The results from the testing, at the specified temperature setpoints, are provided below in tabular and graphic format. MB refers to the meter box, while CB refers to the climate box.

R-15 Dense Pack FG		Test Regime (Interior Exterior Induced Air Flow)					Induced Air Flows (10 Pa)			
	(°C)	22 62	22 42	22 2	22 -18	22 -28	22 -18 10Pa	22 -18 10Pa	22 42 10Pa	22 42 10Pa
	(°F)	72 144	72 108	72 36	72 0	72	72 0 10Pa	72 0 10Pa	72 108 10Pa	72 108 10Pa
Start Date	YY/MM/DD	14/09/06	14/08/09	14/09/11	14/09/12	14/09/19	14/09/16	14/09/18	14/08/17	14/08/20
End Date	YY/MM/DD	14/09/07	14/08/10	14/09/12	14/09/15	14/09/22	14/09/17	14/09/19	14/08/18	14/08/21
MB - Air Temp	°C	21.81	21.83	21.46	21.07	21.04	21.03	21.19	21.81	21.78
CB - Air Temp	°C	62.00	42.00	2.00	-18.00	-28.00	-18.00	-18.00	42.00	42.00
MB - Surf Temp	°C	24.81	23.24	19.92	18.18	17.49	18.00	18.40	23.29	23.16
CB - Surf Temp	°C	60.70	41.26	2.33	-16.93	-26.56	-17.00	-16.93	40.22	40.21
S-S Temp Diff	°C	35.89	18.01	-17.59	-35.11	-44.05	-35.00	-35.33	16.93	17.05
Q - Measured	W	-184.02	-90.63	80.55	156.73	186.44	181.45	141.27	-102.45	-85.40
Q - Air	W	2.48	1.32	-2.36	-5.80	-7.56	-34.03	-38.12	13.93	13.78
Q - Flanking	W	10.28	4.95	-5.02	-14.96	-20.66	-14.94	-15.01	4.96	4.97
Q - Q _{tas}	W	NA	NA	NA	NA	NA	0.00	-0.59	0.24	-0.12
Q - Net	W	-173.74	-85.68	75.53	141.77	165.78	166.51	125.67	-97.49	-80.55
RSI	(m ² K/W)	1.81	1.85	2.04	2.17	2.33	1.84	2.47	1.52	1.86
R-Value	(ft ² F·h/Btu)	10.29	10.48	11.61	12.34	13.24	10.47	14.01	8.65	10.55

*Thermal resistance calculated by dividing the total corrected heat flow by the surface area of the sample and the surface temperature differentials between the meter box and the climate box.

The total heat flow (Q_{total}) is calculated by using the measured heat flow required to maintain 22°C ($Q_{measure}$) then applying correction factors for the heat moved from airflow (Q_{air}) and the amount of heat that bypasses the wall cartridge ($Q_{flanking}$). The R-value is obtained by multiplying the wall area and surface-to-surface (S-S) temperature difference by the inverse of the total heat flow. The R-values at each climate box setpoint, including the induced air flow R-values, are provided in the plot below.

R-15 Dense-Packed Fiber Glass w/ Latex Caulk Air Sealing – Report Summary

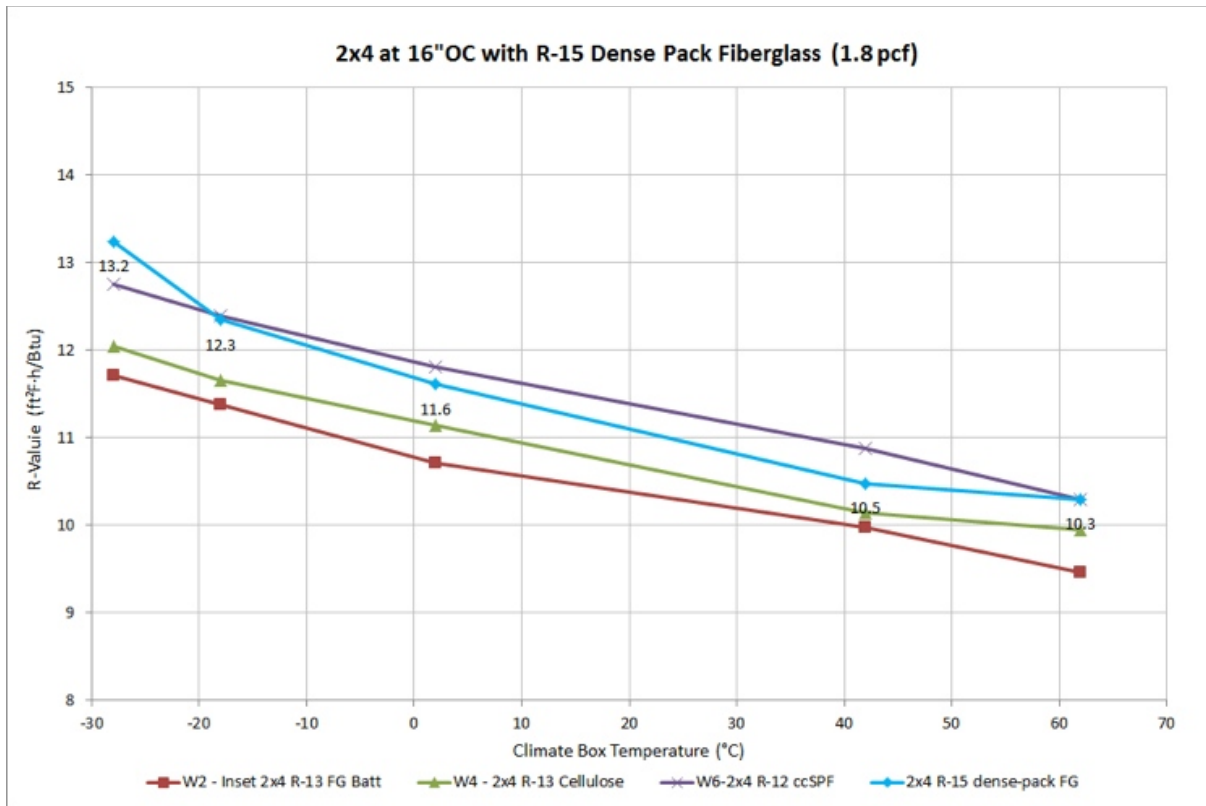

The R-15 batt wall is also included in the plot below.

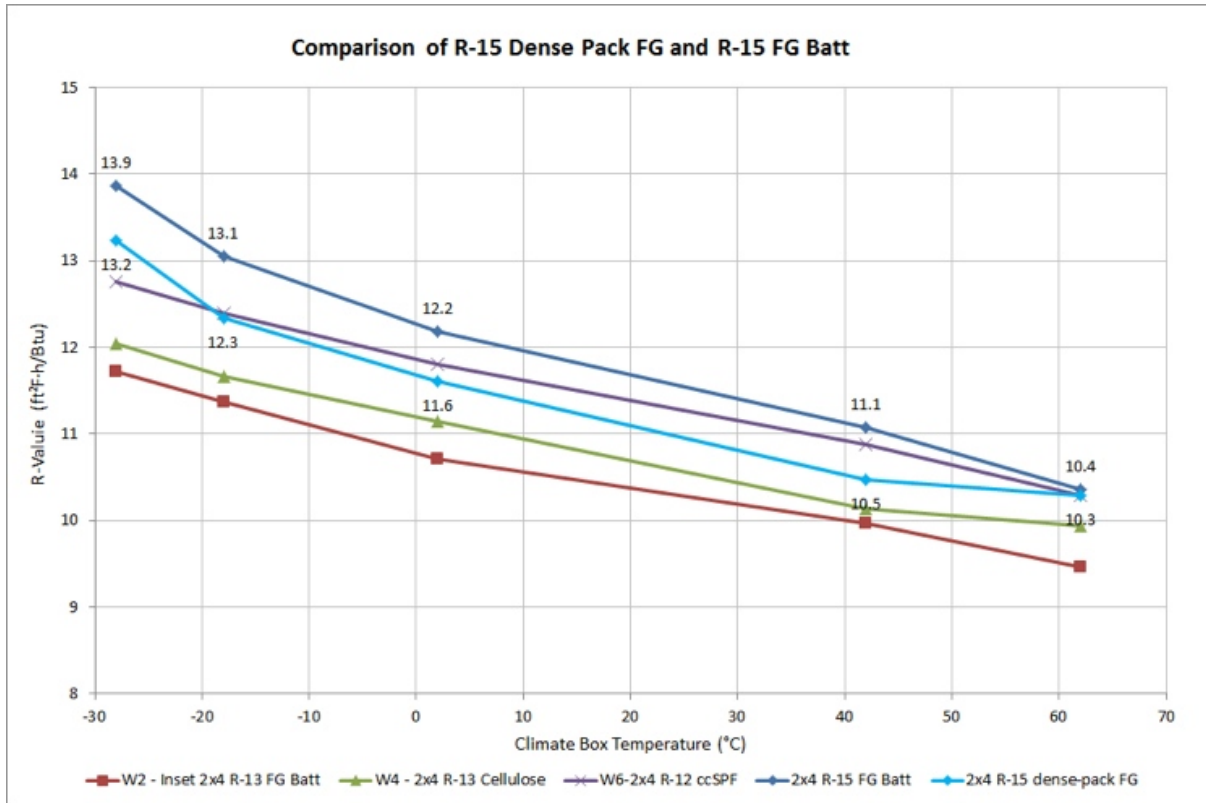

R-15 Dense-Packed Fiber Glass w/ Latex Caulk Air Sealing – Report Summary

The R-15 dense pack was installed with an average density of 1.8 pcf in each of the 16” stud bays. The following table shows the criteria and specifications used by the installer to achieve the desired 1.8 pcf installation density.

Bay Height (in)	90		Total Installed Weight (lb)	42.2
Bay Width (in)	14.5		Number of Bays	9
Bay Depth (in)	3.5		Weight per Bay (lb)	4.7
Bay Volume (in ³)	4568			
Bay Volume (ft ³)	2.64			
Total Wall Volume (ft ³)	23.8		Installed Avg. Density (lb/ft ³)	1.78

Upon completion of TM testing, the insulation was removed from the wall and documented. Each stud bay (SB) was divided into an upper, middle and lower section of 30”. The dense pack fiberglass was removed and weighed to determine the density distribution within that area of the wall. The table on the following page shows the sample areas and the density of material found in that area.

The three areas with shaded backgrounds in the table on the following page are the areas where material was sourced for later use in conductivity testing. There is no industry standard (ASTM or otherwise) for collecting conductivity samples from existing installations of dense-packed fiber insulation material. BSCI endeavored to remove insulation samples and create conductivity samples in a logical, representative, and repeatable manner. The material in the shaded areas was carefully removed and placed into a container. The container was weighed to determine the mass of the material in the 30” section of the stud bay. The stud bay width, depth, and height were accurately measured to determine the volume of material removed. The density was then calculated. These data indicate that while the average density within the stud bay was 1.8 pcf, the distribution of the fiberglass varied from 1.4 pcf to 2.2 pcf. The highest variability was observed in SB 3 where one of the electrical outlets was positioned. The density of fiber glass in this bay ranged from 1.4 pcf to 2.2 pcf.

A portion of the sampled insulating material was placed into a 12” x 12” lightweight plastic frame with 3” high walls and a floor of the filter cloth netting (i.e. the same netting as used in the test wall). The density range of the test wall was intentionally recreated in the samples used for conductivity testing. A layer of filter cloth netting was then put over the container to contain the insulating material.

The thermal conductivity of six samples was tested using the C518 apparatus. It should be noted that, since these samples were prepared using material removed from the test wall, the insulation was disturbed in the process and may not absolutely reflect the fiber orientation and small-scale density distribution that existed in the full wall assembly. As a consequence, the conductivity samples may not be entirely representative of the material in the wall system. The six 3.5 in. (89 mm) thick samples were intentionally prepared to have densities that reflected the range of densities found in the test wall. The R-value testing of these six samples, measured at a mean of 75°F (23.9°C), produced R-values in the range of R-14.0 to R15.1. The average of the six samples was R-14.5 which is 97% of the advertised R-value.

Dense-Packed Fiber Glass Density (pcf)

	[L] SB 1	SB 2	SB 3	SB 4	SB 5	SB 6	SB 7	SB8	SB 9 [R]
Top	1.7	2.1	2.2	1.9	1.9	1.7	2.0	1.9	2.1
Middle	1.7	1.6	2.0	1.7	1.7	1.7	1.7	1.8	1.7
Bottom	1.8	1.8	1.4	1.7	1.9	1.9	1.7	1.7	1.6
Average	1.8	1.8	1.9	1.8	1.8	1.8	1.8	1.8	1.8